

EXTRACTION CHROMATOGRAPHY

Technical Documentation - Radiopharmacy



Extraction Chromatographic Resins



Specialty Ion Exchange Resins



Novel Separation Materials



Method Development

INDEX

Applications	3
CL Resin.....	4
CU Resin.....	5
DGA Sheets.....	6
ZR Resin.....	7
TK200 Resin.....	11
TK201 Resin.....	13
TK221 Resin.....	15
TK211/2/3 Resins.....	20
TBP Resin.....	23
TK400 Resin.....	24
TK101 Resin.....	27
TK102 Resin.....	28
TK225 Resin.....	30
Guard Resin.....	31
TK202 Resin.....	31
TK-TcScint.....	35
Upcoming new products.....	37
References.....	39

APPLICATIONS

Radiopharmacy

TrisKem manufactures selective resins for the purification and QC of Lanthanides (e.g. Lu-177, Tb-161,...), Cu-61/4/7, Zr-89, Ga-68, Ac-225, Ge-68, Ti-44/5, Sc-43/4/7, Tc-99m and many other radionuclides for medical purposes. We develop rapid, highly specific separation techniques for:

- Separation of radionuclides from irradiated targets
- Quality control of radionuclides for medical use
- Post-generator purification
- Radioprotection and Radioanalysis

Environmental monitoring and Bioassay

TrisKem's extraction chromatographic resins allow the separation and determination of radionuclides (e.g. actinides and fission products) from bioassay samples and environmental matrices e.g. soil, sediment, vegetation and seawater samples. Their use allows a rapid and precise determination of radionuclides in emergency and routine situations, as well as, combined with suitable sample preparation methods, to obtain very low detection limits through analysis of large volume samples.

Decommissioning

The high selectivity of our resins not only allows the analysis of standard alpha and beta emitters (actinides, Sr-89/90, Ni-63, Tc-99,...) from high matrix samples including concrete, spent resin, but also the determination of so called difficult-to-measure (DTM) radionuclides such as Sn-121m/Sn-126, Zr-93,...

We are constantly working on developing new methods according to your needs. Methods for the following radionuclides are currently under development: Se-79, Sb-125, Cs-135, Nb-93m/Nb-94, Ag-108m, Pd-107, ...

Geochemistry and Metals Separation

TrisKem's expertise in separations and its variety of different resins with varying selectivities provides a number of opportunities to solve analytical problems through sample preparation. With our broad offer of products and long experience, TrisKem can help you meet lower detection limits with less uncertainty. The problems encountered are frequently centered on removing matrix that interferes with the instrumental measurement. ICP-MS is an example. Isobaric interferences often have to be removed in order to allow accurate determination of your analytes. Selectivity for the analyte of interest is important in these cases. Extraction chromatography is already widely used in various applications including geochronology, isotope ratio determination and provenancing.



A number of ready-to-use methods are available through our new website: www.triskem.com

CL Resin

The CL Resin is based on an extraction system that is selective for soft cations such as palladium, mercury, gold and silver and it is mainly used for the separation of chloride and iodide, especially in the context of Cl-36 and I-129 analysis, the separation of iodine isotopes and the removal of radioiodine from effluents.

The selectivity for halides is introduced by loading the resin with Ag^+ allowing good selectivity for anions, especially halides, forming sparsely soluble or insoluble Ag complexes. Since the resin retains Ag^+ over a wide range of pH values it also allows loading chloride and iodide from various conditions, from slightly (chloride) to highly alkaline (iodide) to strongly acidic (both), ideally under reducing conditions to ensure their presence as halides.

Radioiodine is considered to be one of the most dangerous radioelements in terms of radiological effects in case of accidental release. Accordingly efforts are made to capture iodine from liquid effluents already during the production process before waste storage, to avoid a possible gas release from stored liquid waste at a later date.

Caroline Decamp of the Institute of Radioelements (IRE) has developed a method for the removal of radioiodine from acidic (1M HNO_3) radioactive process waste solutions. The IRE combined the CL Resin with XAD-4 resin and packed this mix (4g XAD-4 and 3g CL Resin) into columns. These mixed bed columns were then introduced into their process setup in order to remove radioiodine from their multi-curies production process solutions.

One prerequisite of the removal step was that it should not slow down the process; the radioiodine removal was thus tested at the same flowrates applied during the process. Flow rates up to > 180 mL/min and effluent volumes between 12L and 17L were tested, and it was found that under these

conditions between 85 and more than 95% (overall mean retention yield for all solution volumes is $88\% \pm 5\%$ (N = 14, k = 1)) of the radioiodine present were retained on the column, thus lowering the I-131 activity of the effluents by a factor of 10 from 100 GBq/L to about 10 GBq/L. 2000 GBq of I-131 could be removed per decontamination cycle and stored as solid waste.

Mastren et al. used the CL Resins for the separation of Ag-111 from a proton irradiated thorium target. In a second paper they have further shown that the CL Resin may be used to separate Pa from a bulk thorium matrix.

Besides the removal of radioiodine from effluents the CL Resin is also used for analytical purposes. It allows for the preconcentration of I isotopes e.g. from waste water upfront to gamma spectrometry and, more importantly, for the determination of I-129 and Cl-36, both long-lived, volatile radionuclides, in environmental and decommissioning samples.

In case of analytical applications, after loading and rinsing of the resin (removal of matrix elements and interferences), chloride can be easily eluted from the resin using dilute SCN^- solutions whereas iodide remains fixed. Iodide can then be eluted from the resin using a moderately concentrated S^{2-} solution.



Main Applications

- Separation and removal of radioiodine
- Ag separation
- Pa separation
- Cl-36 and I-129 separation

CU Resin

The CU Resin is used for the separation of Cu and is based on a Cu selective extraction system.

The extraction behaviour of the CU Resin towards a number of elements in three different acids at varying acid concentrations is presented here.

Overall the resin shows high selectivity for Cu over all tested cations including Ni and Zn. Cu uptake is generally high at pH values greater than 2 while it can be easily eluted with mineral acids of elevated concentrations. Accordingly it is well suited for liquid target work. For Cu separation from solid Ni targets on the other hand the TK201 resin is more suitable. Further the resin shows high robustness against interference of elevated amounts of Zn and Ni, even at 1 g of Zn or Ni per g of CU Resin employed the $D_w(\text{Cu})$ remains greater than 1000.

A simple and fast method for the separation of Cu from irradiated targets was developed by Dirks. et al. allowing to obtain highly pure Cu in a very small volume in less than 10 min.

DeGraffenreid et al. could show that the CU Resin allows separating Cu from very large Zn targets in high yields and purity. It may be combined with the TK201 Resin to convert the obtained Cu fraction from high acid concentration to dilute acid.

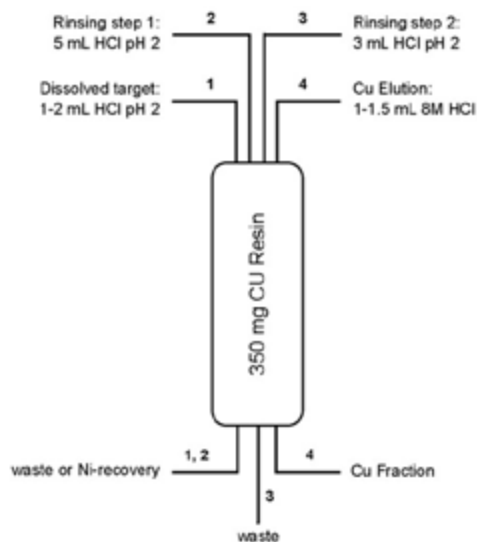

Optimized Cu separation method

Main Applications

- Separation of Cu-64/67 from irradiated targets
- Concentration and separation of Cu from environmental matrices
- Purification of target materials

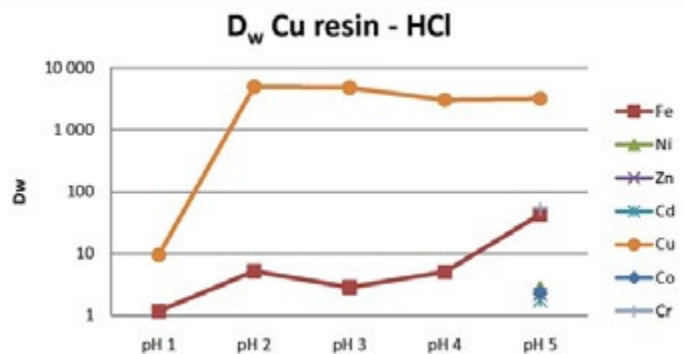

D_w of Cu and selected elements on Cu Resin in HCl in varying pH values.

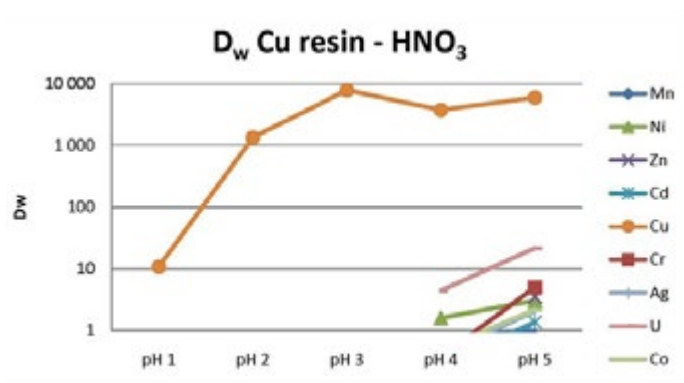

D_w of Cu and selected elements on Cu Resin in HNO₃ in varying pH values.

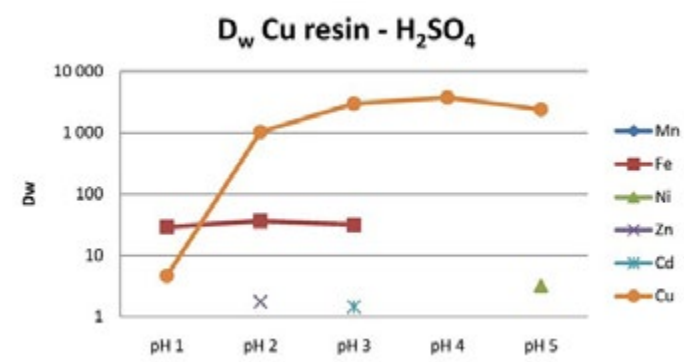

D_w of Cu and selected elements on Cu Resin in H₂SO₄ in varying pH values.

Thieme et al. showed that removing traces of stable Cu from Ni targets will result in a higher specific activity of Cu isotopes produced from such targets.

It could further be shown that Cu can be concentrated, and separated, from other high-matrix samples such as sea water, biological and mining samples with high yield and purity.

DGA Sheets

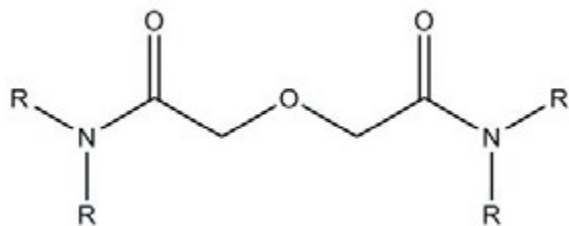

Radionuclide separation and radionuclidic purity determination was never easier. Separation of generator isotopes and radionuclide mixtures on DGA impregnated chromatographic paper, which has been developed at the CVUT, including mixtures like Ac-227/Th-227/Ra-223, Sr-90/Y-90, Ge-68/Ga-68, Mo-99/Tc-99m, Pb-212 and Ac-225/Bi-223 is now...

and Ac-225, Bi-213 is now possible using one separation material, just by changing the composition of the mobile phase (diluted mineral acids like 1M HNO₃ or HCl). The chromatographic paper is impregnated with DGA with variable active compound loading (0.1-10%).

The method is easy to validate and TLC scanners or alternatively, after cutting the paper, common radiometers may be used to determine radionuclidic purity of a generator eluate or a purified radionuclide product.

Proposed standard sheet dimensions are 5 x 20 cm, 10 x 10 cm or 20 x 20 cm. Other formats and custom dimensions are however also available upon request.

You'll find two application notes on our website.

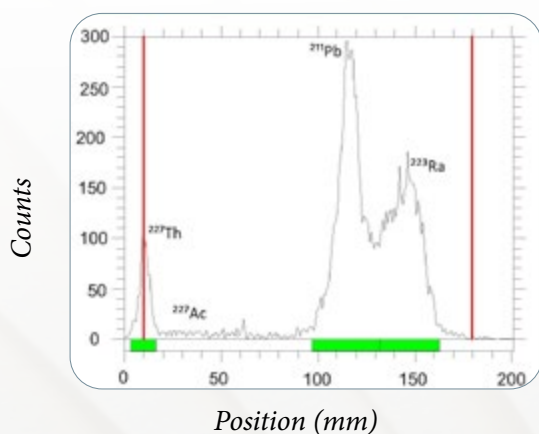

Radiochromatogram measured immediately after separation

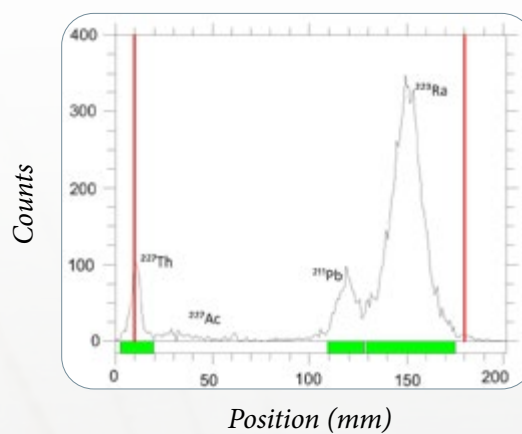

Radiochromatogram measured one hour after separation

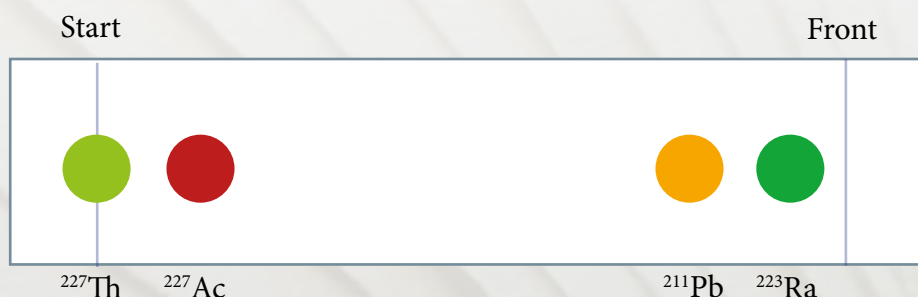

Scheme of a chromatographic separation of a mixture of Ac-227 and its descendants. Th-227 remains on start, Ac-227 has a retention factor R_f of ca. 0.2, Pb-212 of ca. 0.7 and Ra-223 of ca. 0.9.



All data provided by J. Kozempel and M. Vlk, CVUT

ZR Resin

The ZR Resin is based on the hydroxamate functionality frequently used for the separation of zirconium, especially from Y target materials, for later use in radiopharmaceutical applications.

Dirks et al. characterized the resin with respect to its selectivity for selected elements in HNO_3 , HCl and oxalic acid; results are summarized in the following figures.

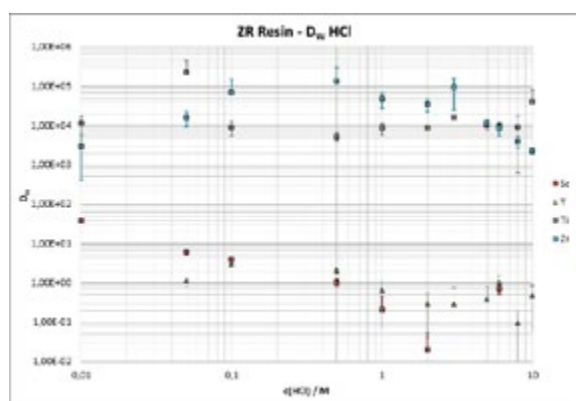

D_W values, ZR Resin, HCl, various elements

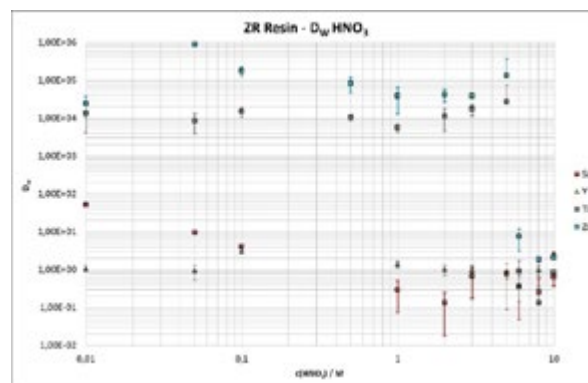

D_W values, ZR Resin, HNO_3 , various elements

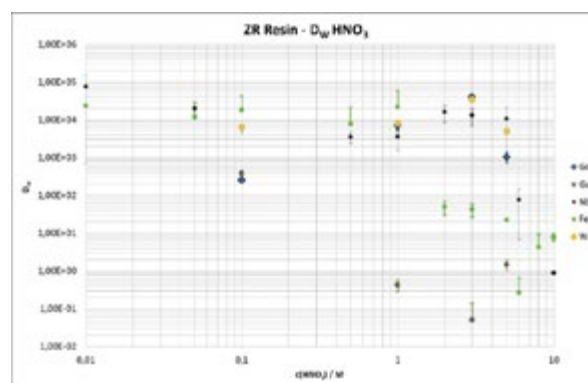

D_W values, ZR Resin, HNO_3 , various elements

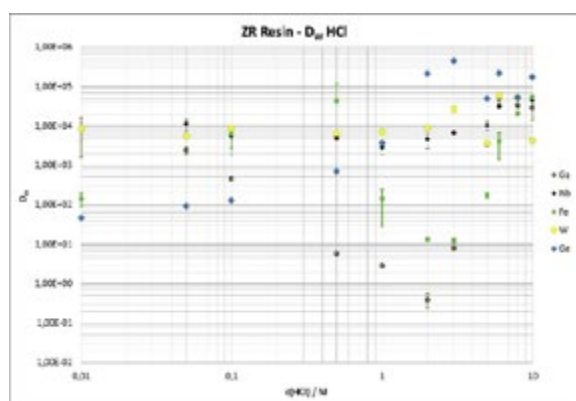

D_W values, ZR Resin, HCl, various elements

The ZR Resin shows high selectivity for Zr, Ti and Nb over a wide range of HCl concentrations (0.01M – 10M), Fe(III) is strongly retained at low and elevated HCl concentrations, retention is weak from 1 – 6M HCl. As expected, the resin shows very little selectivity for Sc and Y, a separation e.g. of Zr from Y and of Ti from Sc seems thus feasible.

The resin further shows quite interesting selectivity with respect to Ga and Ge.

Ga is very well retained at low HCl concentrations ($\leq 0.1\text{M}$) as well as at high concentrations ($\geq 5\text{M}$ HCl), while Zn e.g. is not retained at all. At HCl concentrations in-between, particularly at 1-2M HCl it is not retained. Ge on the other hand is very well retained at HCl concentrations $> 0.1\text{M}$. Especially at 2M HCl the selectivity for Ge over Ga is very high.

The resin shows rather similar selectivity in HNO_3 . Zr, Ti and Nb are well retained up to 5M HNO_3 , Fe(III) is well retained up to 1M HNO_3 . At higher HNO_3 concentrations the nitric acid starts decomposing the extractant, as indicated by a colour change of the resin from white to brown; accordingly, the resin shows no significant selectivity towards the tested cations under these conditions. As in HCl, Y and Sc show no significant retention on the ZR Resin in HNO_3 .

It should be noted that the ZR Resin also shows high selectivity for Ge over Ga (and Ni/Co) at elevated HNO_3 concentrations.



D_W values, ZR Resin, HNO_3 , various elements

Oxalates are very strong complexing agents for Zr, accordingly they are very frequently used for the elution of Zr.

It could be shown that oxalic acid concentrations above 0.05M lower the D_w value of Zr on the ZR Resin strongly; they are thus suitable eluting agents for Zr. It was further observed that Nb shows rather elevated D_w values even at 0.05M oxalic acid, indicating that Zr and Nb may be separated by adjusting the oxalic acid concentration accordingly.

Based on obtained D_w values several elution studies were performed with main focus on the use of the resin in the context of radionuclide production for radiopharmaceutical use.

As indicated by the D_w values, the ZR Resin will retain Zr over a range of HCl concentrations. The rinsing conditions were kept close to the conditions suggested by Holland et al.: after loading the resin it is first rinsed with 4 x 2.5 mL 2M HCl, followed by an additional rinse with 4 x 2.5 mL water. Zr is finally eluted using 0.05M oxalic acid or higher.

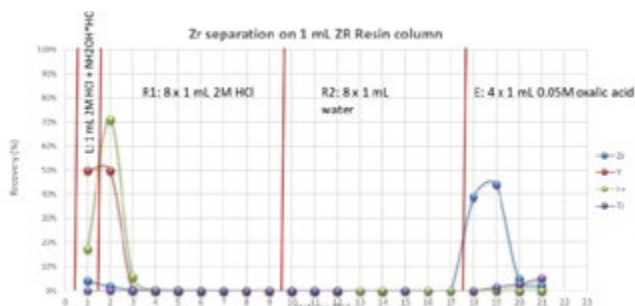

Elution study ZR Resin, 100 mg, various elements, fractions analysed by ICP-MS

Under the given conditions a very clean separation of Zr from Y, Ti and Fe was obtained. Y and Fe are removed during the loading and rinsing of the ZR Resin, while Ti remains retained on the resin. Zr can be recovered quantitatively in ~2 bed volumes (BV) of 0.05M oxalic acid. High chemical yields could be obtained even in presence of up to 300 mg stable Y (using 100 mg ZR Resin).

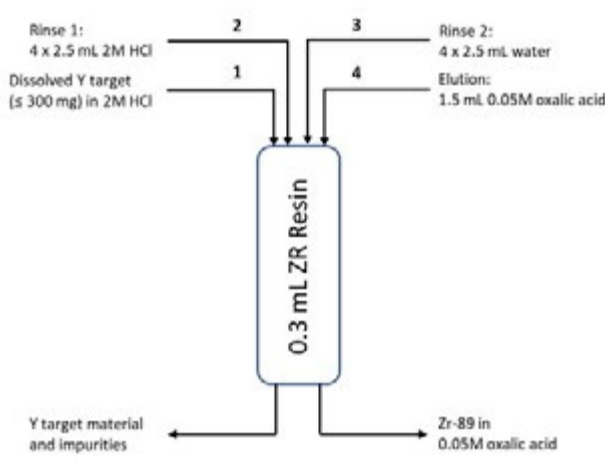

Suggested method for the separation of Zr from Y targets (≤ 300 mg) using the ZR Resin.

The ZR Resin is currently also being tested for use in radioanalytical applications such as the quantification of Zr-93, as well as, in combination with the TK400 Resin, the separation of Fe/Nb/Mo, e.g. in decommissioning samples.

Another increasingly important use of the ZR Resin is the purification of Ga-68 from irradiated Zn targets. The production of Ga-68 via the irradiation of Zn-68 (as liquid or solid targets) on a cyclotron is indeed increasingly finding use as an alternative to Ge-68 generator produced Ga-68, as it allows frequent production of high activities.

As shown in the D_w value graphs the ZR Resin retains Ga very strongly in dilute HCl and HNO_3 , as well as in HCl of elevated concentration ($\ge 5\text{M HCl}$). Zn on the other hand is not retained under any of these conditions. This selectivity allows its use for the separation of Ga-68 (and Ga-67) from irradiated Zn targets - liquid targets (typically dilute HNO_3) as well as solid targets (typically dissolved in HCl of high concentration).

HCl between 1M and 2M on the other hand is very suitable for Ga elution as its retention is particularly low under these conditions.

The following graph shows a typical example of such a separation. While Zn, and other typical impurities such as Cu and Ni, are not retained on the ZR Resin (in this example from high HCl) Ga is very well retained. A clean Ga fraction is then obtained by elution of Ga e.g. with 1.5M HCl.

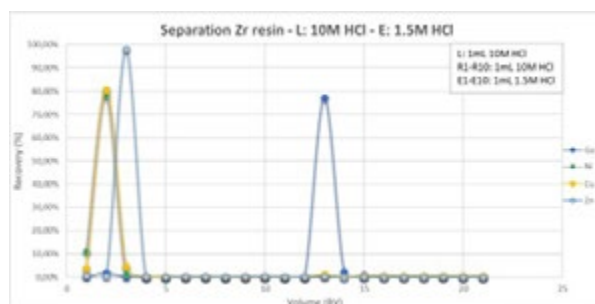

Elution study, Ga separation on ZR Resin, various elements, fractions analysed by ICP-MS

This Ga-68 containing 1.5M HCl solution is too acidic for direct use in labelling or injection. Instead of converting the solution to more suitable conditions e.g. via evaporation and redissolution it is possible to use another resin for this step, the TK200 Resin. More information on the TK200 Resin selectivity may be found in its product sheet, in this context the most important fact is that it retains Ga well in the range of 1 - 2M HCl, while it allows for Ga elution

in dilute HCl or water, making it very suitable for this required conversion.

It should be noted though that while other impurities like Cu are very well removed during load and rinse on the TK200, remaining traces of Zn are only partially removed, accordingly a clean separation on the ZR Resin upfront is very important, as can also be seen in the following elution study.

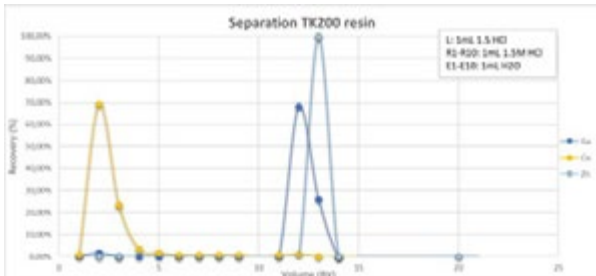

Elution study, Ga conversion on TK200, various elements, fractions analysed by ICP-MS

Several publications describe the use of the combination of ZR Resin and TK200 for the separation of Ga-68 from liquid Zn targets. The publication by Rodnick et al. is particularly interesting as it describes the use of a modified rinse on the TK200 cartridge (2M NaCl/0.13M HCl) instead of the usual rinse with HCl. This allows for recovering the final Ga fraction at a better-defined HCl concentration during elution. The following scheme shows the separation method they developed.

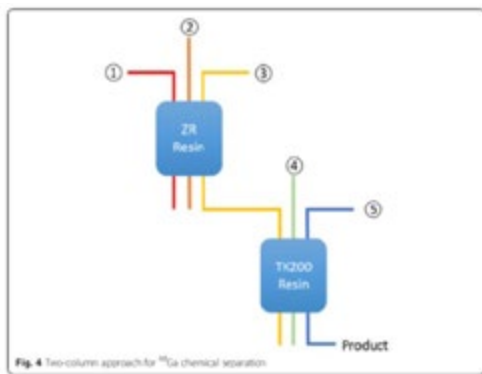

Table 1 High level schemes of $^{68}\text{Ga}/\text{GaCl}_3$ purifications

	Scheme A*	Scheme B
① ZR Load	< 0.1 M HCl ₀	
② ZR Wash	15 mL 0.1 M HNO ₃	
③ ZR Elution / Trapping on TK200	5-6 mL ~ 1.75 M HCl	
④ TK Wash	-	35 mL 20 M NaCl in 0.13 M HCl
⑤ TK Elution	H ₂ O	1-2 mL H ₂ O followed by dilute HCl to formulate

*Process as reported previously (Rahn et al. 2015)

Scheme of Ga-68 separation from liquid Zn targets using ZR Resin and TK200 Resin, taken from Rodnick et al.

Compared to liquid targets the irradiation of solid Zn targets allows for obtaining higher Ga-68 activities per production run.

Thisgaard et al. describe the production of 194 GBq Ga-68 (at end of purification) as $^{68}\text{Ga}/\text{GaCl}_3$ of high purity, and it's subsequent successful use for the labelling of PSMA-11 and DOATATE. The authors

used a three-resin method for the separation. An additional LN Resin cartridge is used between the ZR Resin and the TK200 Resin to further remove potentially present impurities, particularly Fe.

The ZR Resin further shows very interesting selectivity for Ti, especially with respect to Sc.

The graph below shows an example of a Ti/Sc separation performed on the ZR Resin, while Sc is not retained from 10 M HCl Ti is fixed very well. 0.1M citric acid may then be used to elute Ti from the resin. However, the elution requires up to 10 bed volumes (BV) of the eluent or more. Beside citric acid, hydrogen peroxide or oxalic acid of elevated concentration may also be employed.

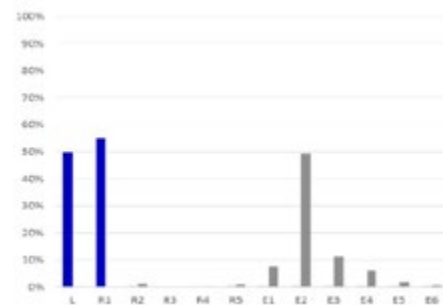

Ti/Sc separation on ZR Resin (0.3 mL), fractions analysed by ICP-MS

As Ti is retained over a very wide range of HCl concentrations, including dilute HCl, its potential for use as support for a Ti/Sc generator was also evaluated initially. In order to do so a 100 mg ZR Resin column (0.3 mL) was loaded with a small volume of a solution containing Ti and Sc. The column was then rinsed five times with 1 mL 0.01M HCl, followed by 10 rinses with 5 mL 0.01M HCl. Sc is easily removed in a small volume of dilute hydrochloric acid whereas Ti remains retained throughout the experiment, the general selectivity of a generator is thus given.

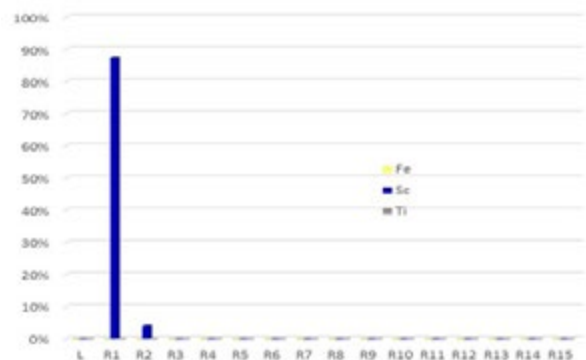

Elution study on 100 mg ZR Resin, Ti and Sc, load from 0.01M HCl, repeated elutions, fractions analysed by ICP-MS

Radchenko et al. examined the system in greater detail and using real, irradiated samples. They confirmed the ZR Resins selectivity for Ti over Sc, shown by the Kd values the author obtained.

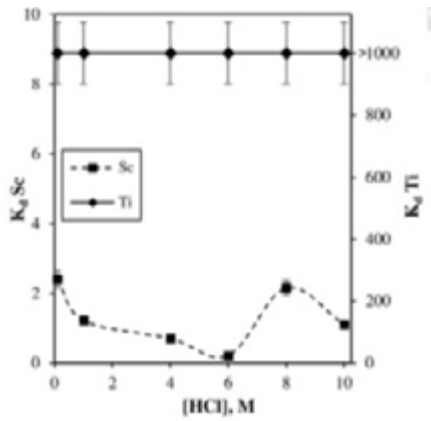

K_d values for Sc and Ti in HCl on ZR Resin, taken from Radchenko et al.

Based on these values they developed a separation method for the purification of Ti, to be more precise Ti-44, from irradiated Sc targets of elevated size (4 g). The graph below shows the elution profile they obtained.

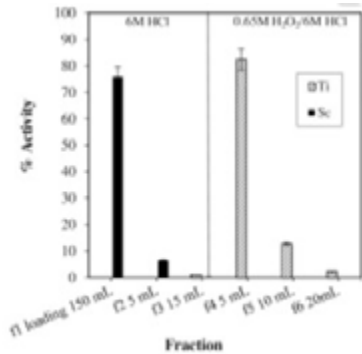

Ti/Sc elution profile on ZR Resin, irradiated 4g Sc target, taken from Radchenko et al.

As may be seen a clean Ti separation from Sc was obtained. The Ti-44 was obtained as an HCl/H₂O₂ solution.

The authors used the purified Ti-44 solution for the preparation of two types of Ti-44/Sc-44 generators, one direct flow generator and, the preferred option according to the authors, one 'forward/reverse flow' generator.

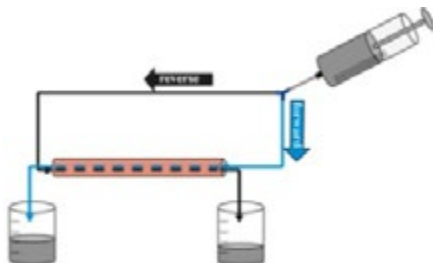

Schematic of a forward/reverse flow radionuclide generator, taken from Radchenko et al.

Especially the 'forward/reverse flow' generator showed very promising results with stable very low Ti breakthrough and high Sc elution yields. The obtained Sc-44 was successfully used to perform DOTA labelling with high yields, further indicating its high purity.

Malinconico et al. also used the ZR Resin to produce Ti-45 from irradiated Sc-45 targets.

Besides for the purification of Ga-68 from Zn targets the ZR Resin may actually also be used for the separation of Ge-68 from irradiated GaNi or GaCo targets. As discussed before, while Ga is very well retained at low mineral acid concentrations (typically $\leq 0.1M$) and at high HCl concentrations, it is not retained at medium high HCl and HNO₃ concentrations, and medium to high H₂SO₄ concentrations. Ge on the other hand is very well retained at elevated mineral acid concentrations. The D_w values show that especially between 1M – 3M HCl and HNO₃ the Ge retention is significantly higher than Ga retention.

It could be shown that the same is true for e.g. 5M H₂SO₄. The ZR Resin further shows no selectivity for Ni or Co under these conditions.

While the selectivity for Ge over Ga is very high in HCl its use for Ge separations is often avoided due to the high volatility of GeCl₄. In H₂SO₄ on the other hand Ge is not volatile, it further allows an efficient dissolution of typically employed target materials. Accordingly, a method for the separation of Ge-68 from multi gram irradiated GaNi or GaCo targets is currently being optimized.

The method is based on two subsequent purification steps on ZR Resin. First the dissolved target is adjusted to 5M H₂SO₄ and then loaded onto a 2 mL ZR Resin cartridge. After rinsing with 5M H₂SO₄ and purge with air for acid removal Ge is eluted with dilute citric acid. The Ge fraction is again adjusted to 5M H₂SO₄ and further purified on a 1 mL ZR Resin cartridge. Ge is once more recovered in dilute citric acid. In order to obtain the final product in dilute HCl (typically 0.05M HCl) the Ge is converted from citric acid to dilute HCl by adjusting it to 9M HCl, loading onto a Guard Resin cartridge, followed by elution with water or dilute acid. Further optimisation of the method is currently on-going.



Main applications :

- Separation of zirconium
- Separation of gallium
- Separation of germanium
- Separation of titanium

TK200 Resin

The TK200 Resin is based on TriOctylPhosphine Oxide (TOPO) an extractant widely used in the extraction of metal ions.

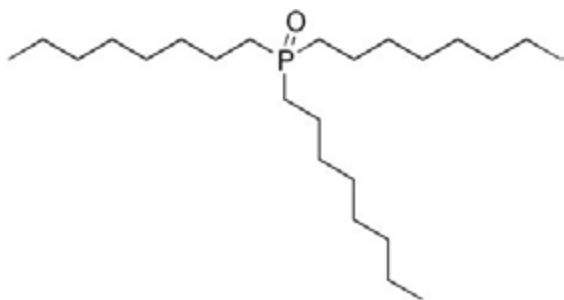

Trioctylphosphine oxide (TOPO)

Some examples of D_w values determined in HNO_3 and HCl using ICP-MS are shown below.

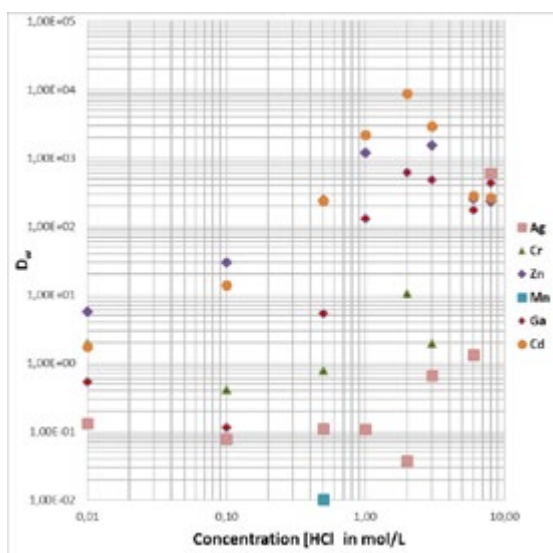

D_w values of selected elements on TK200 Resin in HCl

Cd, Zn and Ga are very well retained at HCl concentrations $>1\text{M}$. This is especially interesting with respect to Ga separation chemistry as Ga is not retained at 1 – 2M HCl on most resins.

In HNO_3 none of these elements are retained incl. e.g. Ga and Zn.

D_w values for a wide range of additional elements may be found in the corresponding product sheet.

A typical example of the use of the TK200 Resin is the separation of Gallium isotopes (especially Ga-68) from irradiated Zn targets for medical use in combination e.g. with the ZR Resin.

ZR Resin is very well suited for the separation of Ga from Zn matrices, under low acid conditions (e.g.

0.1M HNO_3 often employed for liquid targets) as well as at high acid concentrations (e.g. $>5.5\text{M}$ HCl conditions often used for the dissolution of solid Zn targets).

The following elution study shows the separation of Ga from Zn and potential impurities on ZR Resin:

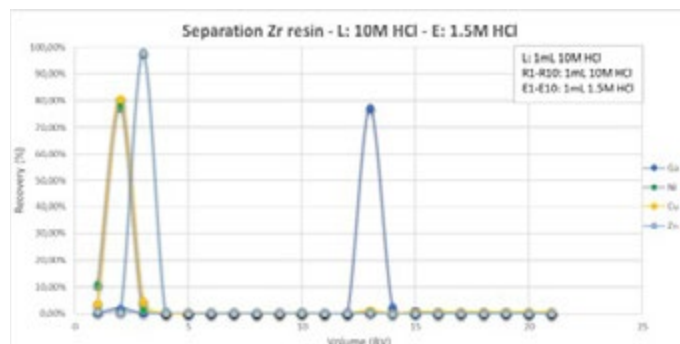

Ga/Zn separation on ZR Resin - load from 10M HCl

Ga is eluted from the ZR Resin in a small volume (1 – 2 column volumes) of 1.5M HCl, conditions too acidic for direct use in labelling reactions.

The TK200 Resin on the other hand allows for Ga extraction at 1.5M HCl, followed by Ga elution using aqueous solutions.

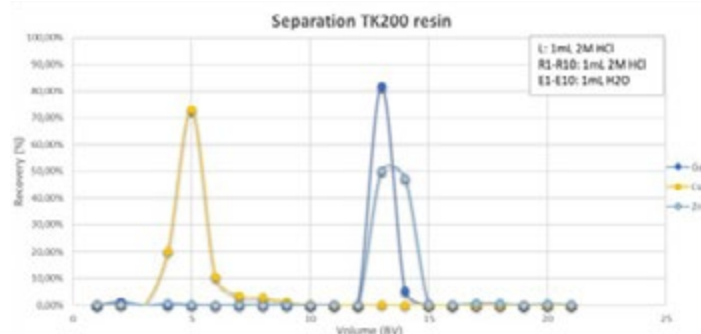

Ga elution from TK200 resin with water following load from 1.5M HCl

It should be noted though that only very little additional Ga/Zn separation is taking place on the TK200 Resin.

Another typical application of the TK200 Resin is the determination of actinides such as U, Th and Pu in water samples

As shown in the following figure, U and Th are very well retained over the whole HNO_3 concentration range, including 0.01M.

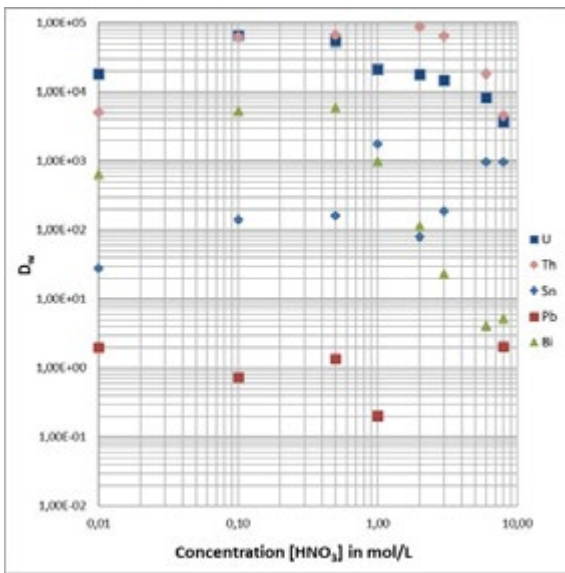

D_w values of selected elements on TK200 Resin in HNO_3

This allows for using the TK200 resin for the preconcentration of actinides from acidified water samples, and their subsequent separation on the same column.

U and Th are also very well retained from HCl.

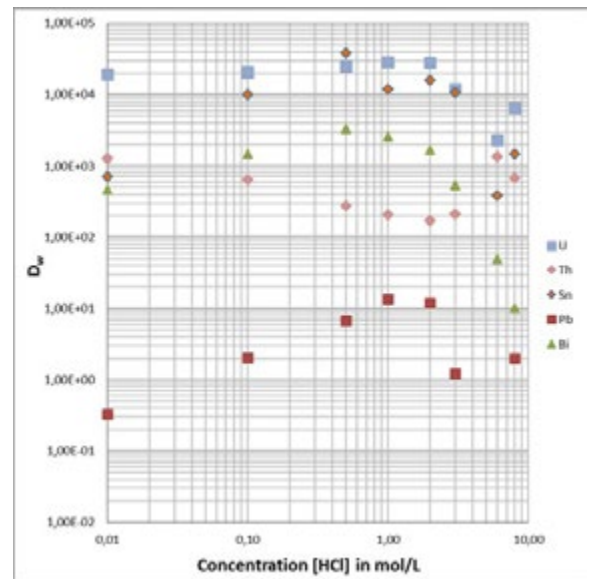

D_w values of selected elements on TK200 Resin in HCl

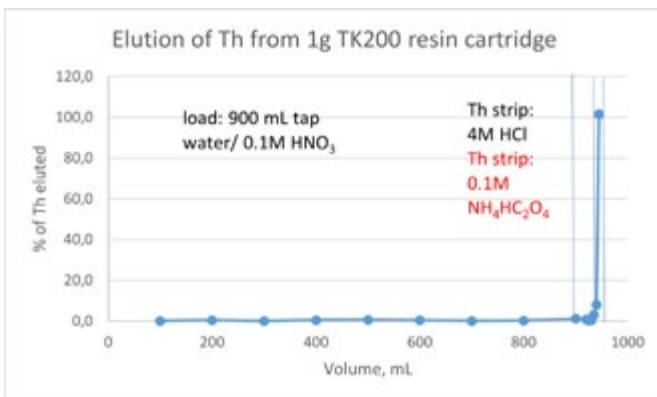

Elution study Th retention and elution on TK200 Resin (data courtesy of Nora Vajda)

A number of other methods are currently being tested, including the separation of Pd from Rh targets, the separation of Pt from Ir targets and Zn from Cu targets.

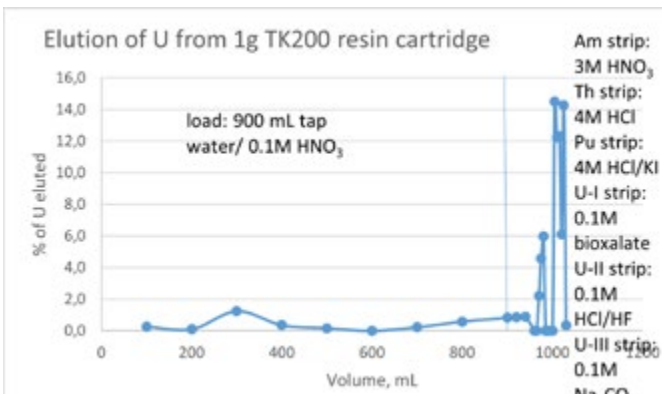

Elution study U retention and elution on TK200 Resin (data courtesy of Nora Vajda)

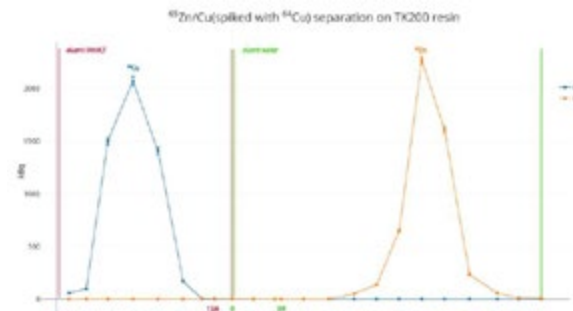

Zn-65 separation. Data provided by Fedor Zhuravlev, DTU

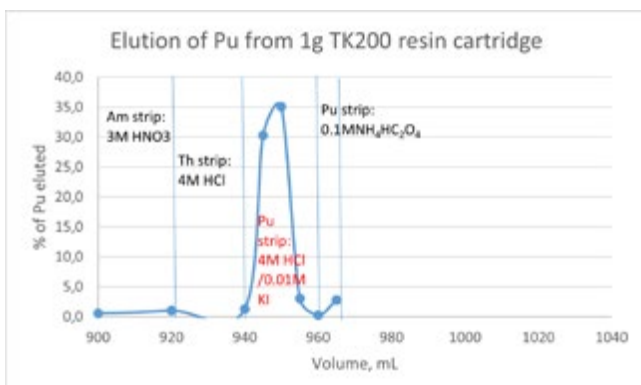

Elution study Pu retention and elution on TK200 Resin (data courtesy of Nora Vajda)

Main applications:

- Ga-68 separation from Zn targets
- Zn separation from Cu targets
- U, Pu, Th concentration and separation

TK201 Resin

The TK201 Resin is based on a tertiary amine, it further contains a small amount of a long-chained alcohol (radical scavenger) to increase its radiolysis stability. The TK201 Resin acts as a weaker ion pair binding agent compared to the TEVA Resin, accordingly it is generally possible to elute it under softer conditions.

Its main applications are the separation of anionic species such as Tc(VII) or Re(VII) and the separation of Cu isotopes from solid Ni targets.

The following graph shows the D_w values for Tc in HNO_3 and HCl.

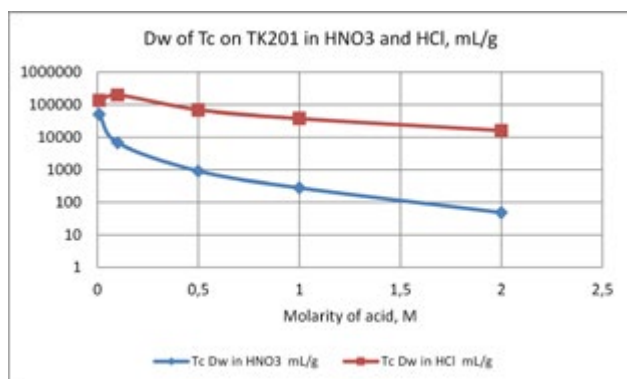

D_w values of Tc on TK201 Resin in HCl and HNO_3 , obtained by LSC, data provided by N. Vajda [RadAnal]

Tc(VII) is very well retained at low acid concentrations. Its retention is generally significantly higher in HCl than in HNO_3 , even at elevated HCl concentration such as 2M it remains very strongly retained. In HNO_3 on the other hand its retention is rather low at concentrations above 2M.

The following graphs show the selectivity of the TK201 Resin for a wide range of elements in HCl and HNO_3 . All D_w shown in these graphs were obtained through ICP-MS measurements.

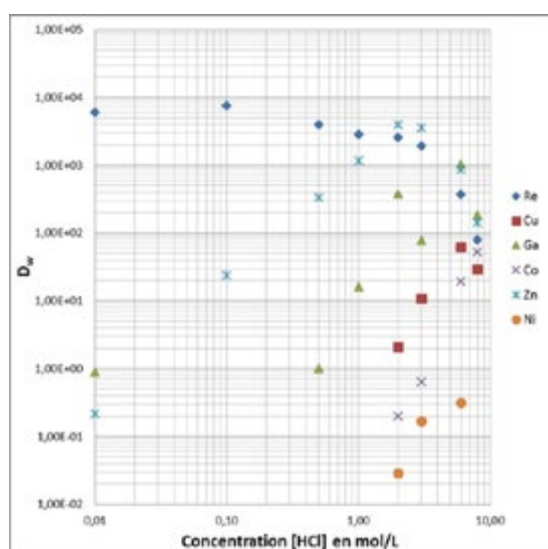

D_w values of selected elements on TK201 Resin in HCl

As expected, the TK201 Resin shows strong Re(VII) retention in HCl even at high concentrations. Further Zn, Ga and Cu are retained, especially the latter allows for its use in radiopharmaceutical applications.

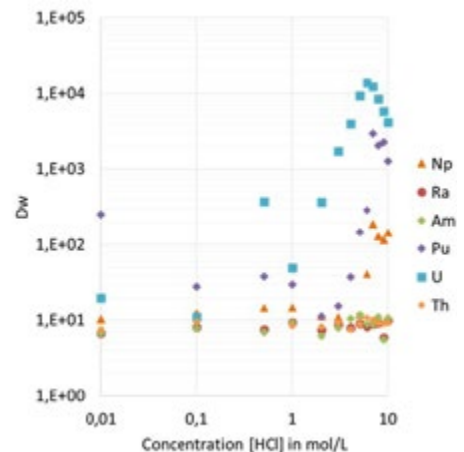

D_w values of selected elements on TK201 Resin in HCl, data provided by Russel et al. [NPL]

The TK201 Resin also shows strong retention of U and Pu at elevated HCl concentrations, both might subsequently be eluted in dilute acid.

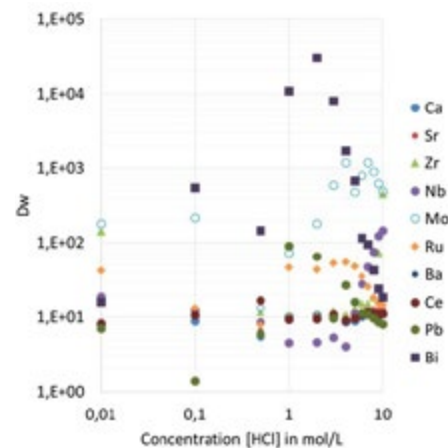

D_w values of selected elements in TK201 Resin in HCl, data provided by Russel et al. [NPL]

The TK201 Resin further strongly retains Bi and Mo at elevated HCl concentrations, while other elements tested show no or only very low retention (Ru, Nb).

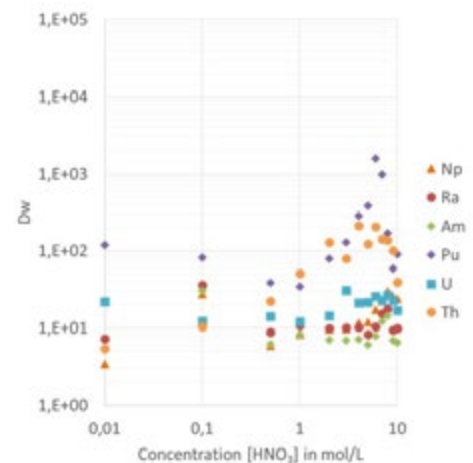

D_w values of selected elements on TK201 Resin in HNO_3 , data provided by Russel et al. [NPL]

The TK201 Resin generally shows rather limited selectivity in HNO_3 , besides for Re and Tc at low acid concentration. At elevated HNO_3 concentrations Pu is well retained and Th fairly well, other actinides are not retained under these conditions.

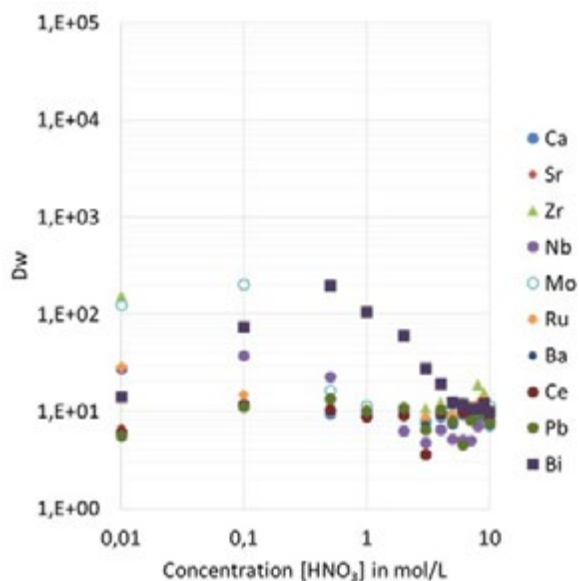

D_w values of selected elements on TK201 Resin in HNO_3 , data provided by Russel et al. (NPL)

Out of the other elements tested only Bi (at about 0.5M HNO_3) and Mo (at low HNO_3 concentrations) are retained significantly. It is important to note that Mo is not retained at HNO_3 concentrations above 0.5M while Tc and Re are well retained (shown on the 1st figure), allowing for their clean separation.

It could further be shown by Vajda et al. that D_w values for Tc(VII) are very low in dilute NH_4OH : in 0.1M NH_4OH Tc(VII) shows a D_w of only ~2, accordingly it is easily eluted by $\geq 0.1\text{M}$ NH_4OH .

Additional elution studies indicated that an efficient Mo separation from Re is possible using 0.7M HNO_3 for Mo removal and dilute NH_4OH for Re elution.

Vajda et al. could confirm that Tc is, like Re, not eluted in 0.7M HNO_3 , validating that Re is a good surrogate for Tc and thus also allowing an efficient Mo/Tc separation. Most suitable conditions for Tc elution were found to be NH_4OH greater or equal to 0.2M.

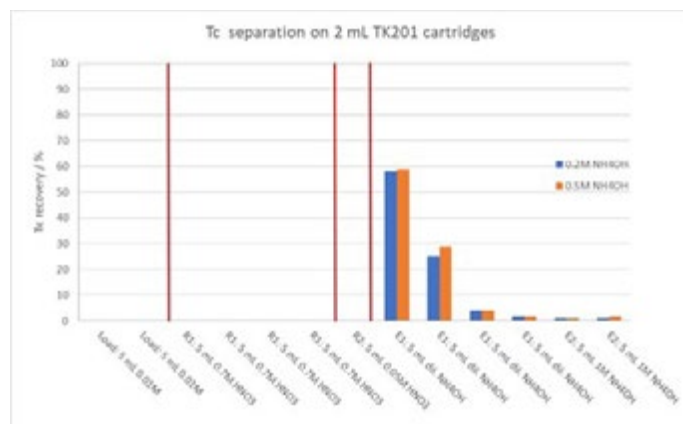

Elution study, Tc separation on 2 mL TK201 cartridges, data provided by N. Vajda (RadAnal)

The other main application of the TK201 Resin is the separation of Cu isotopes (e.g. Cu-64) from solid Ni targets. Other than the CU Resin the TK201 Resin allows for Cu retention from high HCl (e.g. 6M), while letting Ni pass for subsequent recycling. Other potential impurities (e.g. Co) may be removed through rinses with 4 – 5M HCl. Cu may then be eluted in dilute HCl leaving Zn on the column.

A typical separation is shown in the graph below.

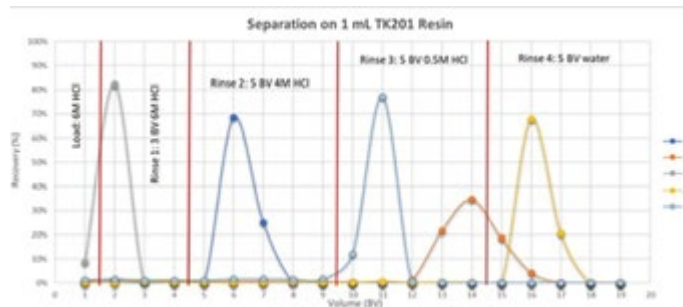

Elution study, Cu separation on 1 mL TK201 cartridges

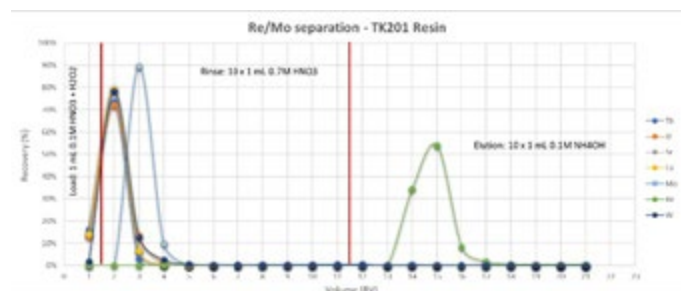

Elution study, Re separation from various elements (incl. Mo and W).

In order to remove Fe and Ga impurities potentially present the dissolved Ni target (6M HCl) may first be loaded through a small TBP (or TK400) cartridge which will retain both elements while letting Ni, Cu and Zn pass onto TK201 for further purification. Cu may then be eluted from TK201 e.g. in 0.05M HCl. This could be demonstrated i.e. by Svedjehed et al. The rinse with 5M NaCl/0.05M HCl is particularly noteworthy as it allows obtaining the final product in dilute HCl solution of defined concentration.

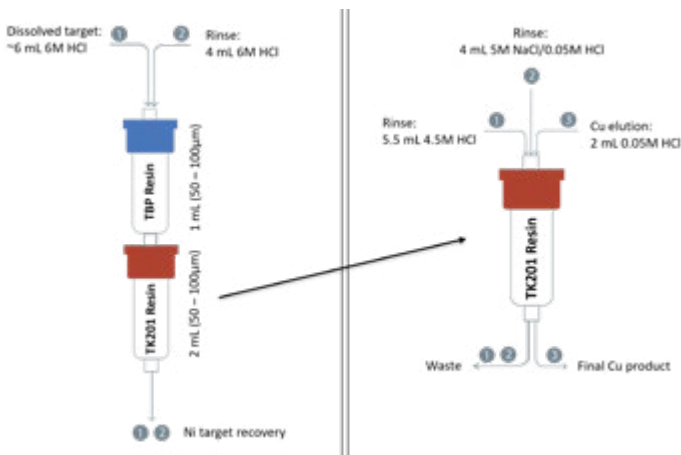

Cu separation using TBP and TK201 Resins according to Svedjehed et al.

TK201 may also be used to convert the Cu fraction eluted from the CU Resin (e.g. for the separation of Cu isotopes from Zn targets) from a highly acidic solution (e.g. 6 - 8M HCl) to conditions more suitable for labeling (e.g. dilute HCl). TK201 will retain Cu e.g. from 6M HCl and can then be eluted with dilute HCl as shown e.g. by Kawabata et al. This will also ensure further Zn removal.

Main applications:

- Separation of Cu isotopes from solid Ni targets
- Separation of technetium
- Separation of rhenium

TK221 Resin

The TK221 Resin is based on a mixture of a diglycolamide and a phosphine oxide. It further contains a small amount of a long-chained alcohol and the organic phase is impregnated onto an inert support containing aromatic groups for increased stability against radiolysis.

The following graphs show the selectivity of the TK221 Resin for a wide range of elements in HNO_3 and HCl.

Out of the tested elements only Ca is weakly retained on the TK221 Resin in HNO_3 . Other alkaline, earth-alkaline elements and Al are not retained.

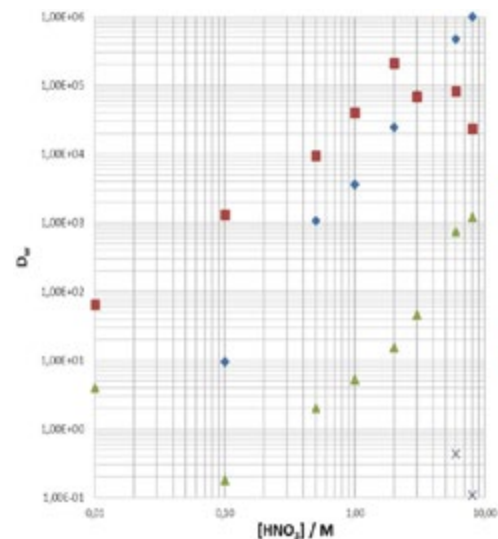

D_w values of selected elements on TK221 in HNO_3

A wide range of transition metals such as Zn, Ga, Co, Ni and Cu are not retained from nitric acid.

The TK221 Resin generally retains tetravalent elements such as Zr and Hf at elevated HNO_3 concentrations.

The TK221 Resin shows very high retention of lanthanides at HNO_3 concentrations $\geq 0.1\text{M}$. Heavy lanthanides are even well retained in more dilute HNO_3 ($\geq 0.01\text{M}$). The retention of the lanthanides is significantly stronger than on TRU Resin.

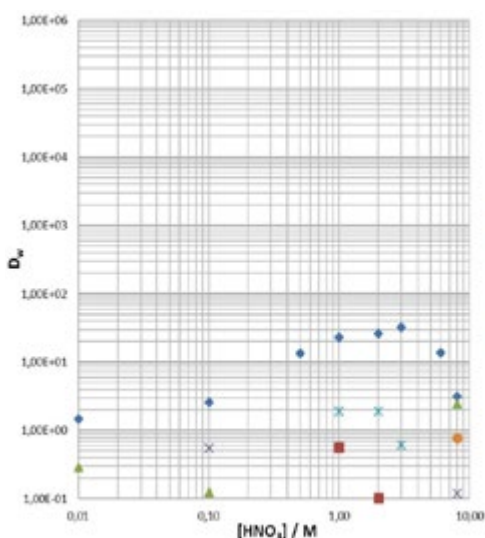

D_w values of selected elements on TK221 in HNO_3

Y and Sc are very strongly retained from HNO_3 of elevated concentration. Fe(III) is also well retained at HNO_3 concentration $\geq 3\text{M}$.

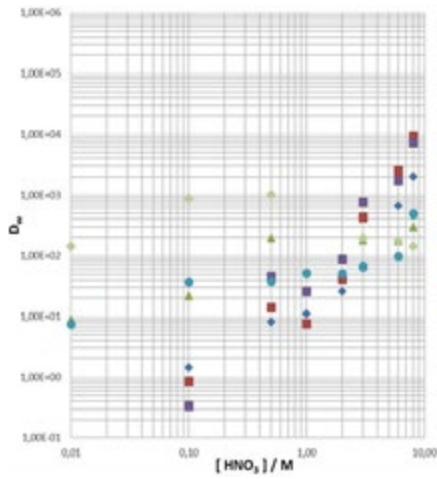

D_w values of selected elements on TK221 in HNO_3

U and especially Bi are well retained over the whole HNO_3 concentration range, while Th is well retained at $\text{HNO}_3 > 0.1\text{M}$. U retention is significantly higher than on other diglycolamide based resins such as DGA Resin. Pb and Sn are only weakly retained.

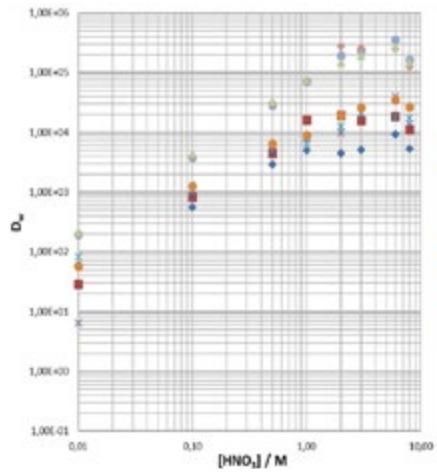

D_w values of selected elements on TK221 in HNO_3

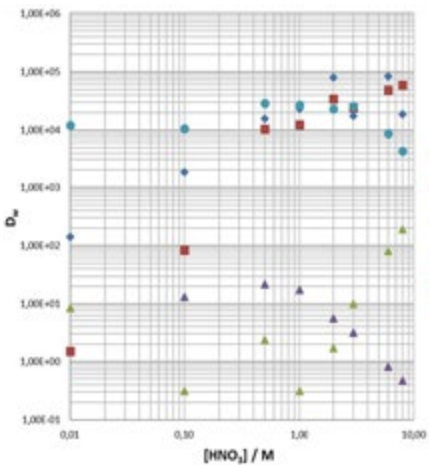

D_w values of selected elements on TK221 in HNO_3

In HCl medium, none of the tested alkaline and earth-alkaline elements were retained on the TK221 Resin the same is true for Al.

Other than many other transition metals, Zn and Ga are very well retained from $\geq 2\text{M}$ HCl. Both may be easily eluted in dilute HCl.

U, Sn and Bi are well retained over the whole HCl concentration range, while Th is only well retained at $\geq 3\text{M}$ HCl. Pb is generally only very weakly retained.

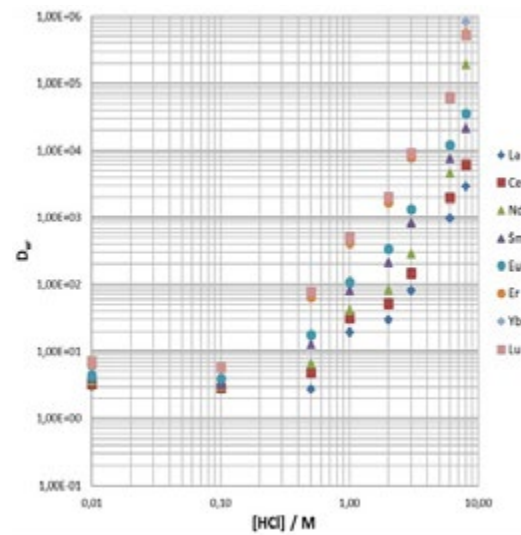

D_w values of selected elements on TK221 Resin in HCl

Lanthanides are generally very well retained at HCl concentrations $\geq 3\text{M}$ HCl, heavy lanthanides even at $\geq 1\text{M}$, and they may be eluted in dilute HCl.

Like the lanthanides Sc, Y and Fe are also very well retained at high HCl concentrations, and eluted in dilute HCl.

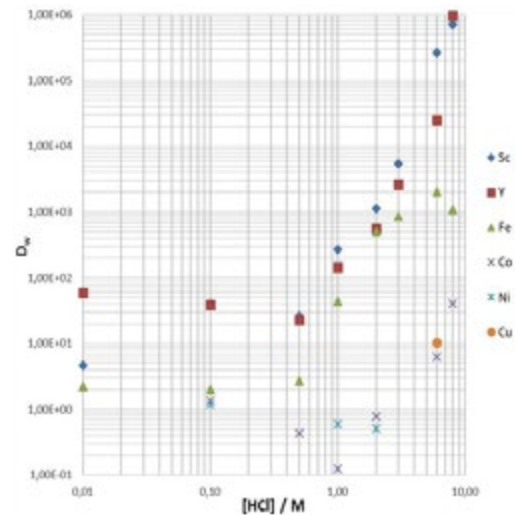

D_w values of selected elements on TK221 in HCl

One of the main applications of TK221 Resin is the concentration, purification and conversion of heavy lanthanides such as Lu from highly acidic solutions into dilute HCl (typically $\leq 0.05\text{M}$ HCl) conditions.

It allows e.g. to elute Lu in a smaller volume than DGA,N Resin. Accordingly, it may e.g. find use in the production of Lu-177.

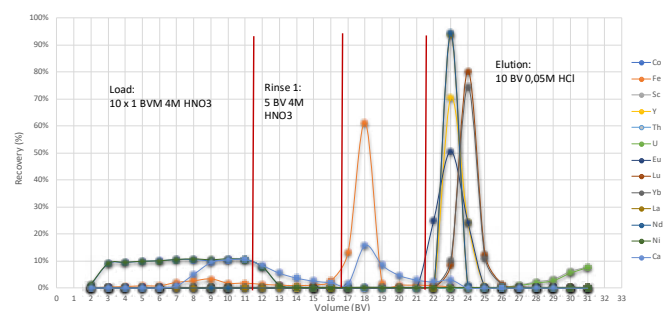

Elution study, various elements on TK221

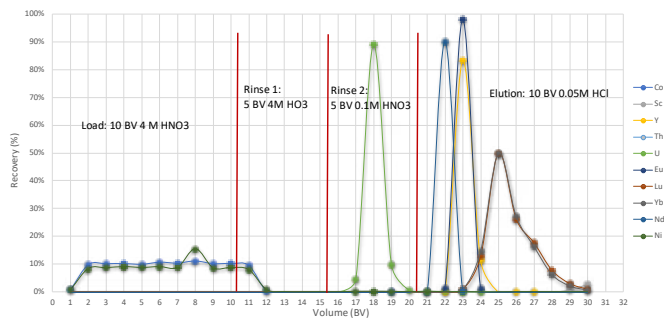

Elution study, various elements on DGA, normal Resin

A number of separation methods based on the TK221 Resin are currently being developed particularly for ca and nca Lu-177 purification, as well as the use of TK221 as part of the separation of nca Lu-177 from up to 500 mg Yb-176.

The final product obtained using the TK221 Resin in the latter separation is typically additionally passed through a 1 mL A8 cartridge for trace nitrate removal.

Such a separation should also be applicable to the purification of Ac-225.

The fact that the TK221 Resin is showing higher U retention compared to e.g. DGA,N Resin might further allow for its use in a two column separation method for sequential actinides separation.

The following figure shows an elution study of several elements including U on TK221.

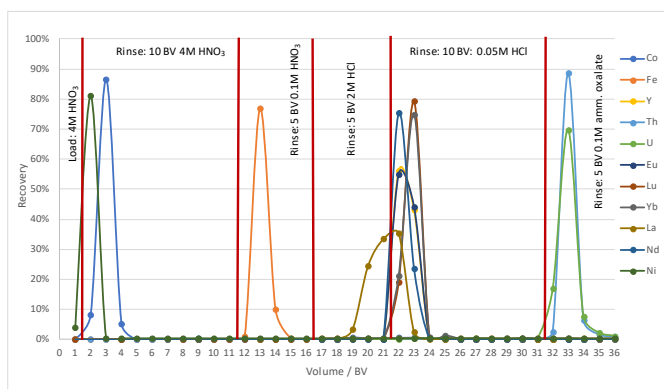

Elution study, various elements on TK221

U is very well retained under all employed HNO₃ and HCl concentrations and may finally be eluted in 0.1M oxalate. Am is expected to be eluted before U in dilute HCl.

With respect to the TK221 selectivity a stacked TEVA/TK221 method for the separation of U, Th, Pu, Am/Cm and Np seems very well possible.

In such a case Np(IV), Pu(IV) and Th(IV) would be retained, and separated, on TEVA while U and Am would pass through TEVA onto TK221 where both would be retained. It should then be possible to first elute Am with dilute HCl and finally U with dilute oxalic acid.

N. Vajda et al. developed such a method for the separation of Th, Pu, Am and U from water samples based on the TEVA/TK221 system. The development work was based on a typical Ca-Phosphate preconcentration step, and took into account the possible presence of Fe(III) originating from the oxidation state adjustment. Through a very thorough optimisation of the Am elution volumes a clean separation of Am and U on the TK221 could be achieved as shown below.

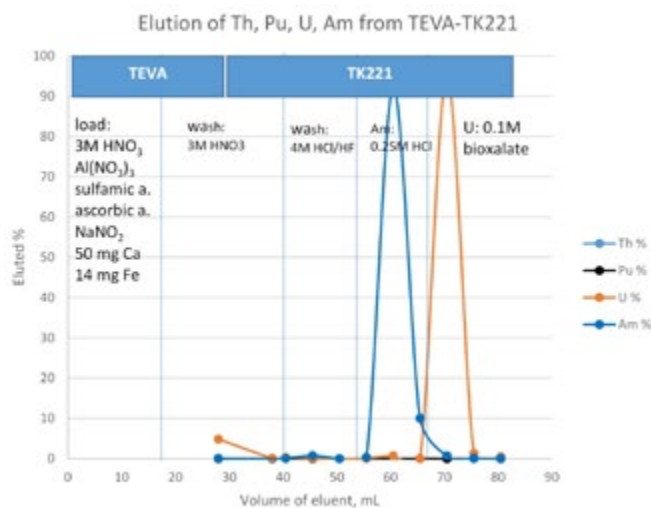

Th, Pu, Am and U separation on 2 mL TK221 cartridge (data courtesy of N. Vajda et al.)

Overall, the authors reported high chemical yields (92 – 106%) under the given conditions, and very good decontamination of the obtained actinide fractions (cross-contamination <1% respectively).

The developed separation protocol is summarized in the following figures.

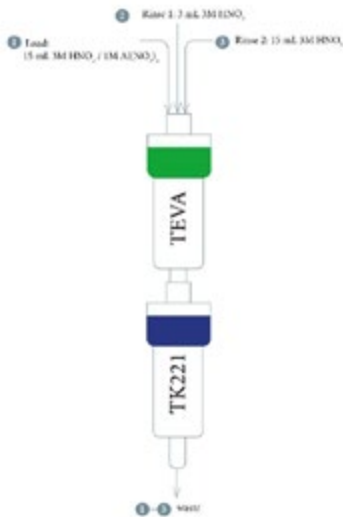

Th, Pu, Am and U separation on TEVA/TK221, stacked cartridges (according to N. Vajda et al.)

The dissolved CaPhosphate precipitate is first passed through stacked TEVA and TK221 cartridges. The cartridges are then rinsed with 3M HNO₃ to assure matrix removal and quantitative transfer of U and Am onto the TK221 cartridge. Both cartridges are then separated: Pu and Th are separated on the TEVA cartridge, while U and Am are separated on the TK221 cartridge.

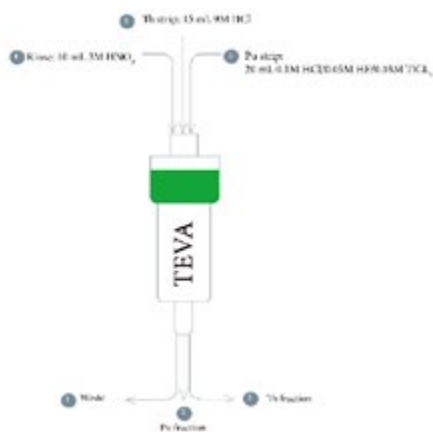

Separation steps on split TEVA cartridge (according to N. Vajda et al.)

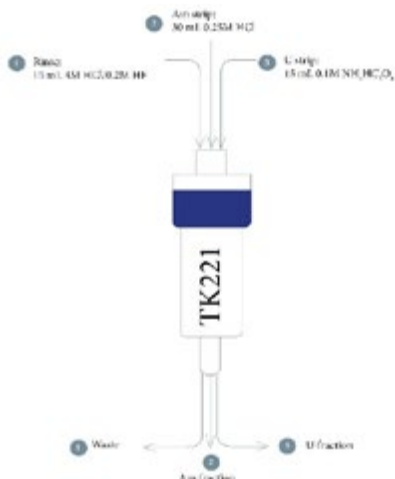

Separation steps on split TK221 cartridge (according to N. Vajda et al.)

When applying the developed method to the alpha spectrometric determination of tap and a sea water samples spiked with Th-230, Pu-239, Am-241 and U-233 they could confirm the clean separation of the actinides, as well as the fact that high chemical yields may be obtained.

Even for a highly charged matrix such as a sea water sample, chemical yields were in the order of ~90% for U, Pu and Am and ~70% for Th, only about 10 - 20% lower compared to the tap water samples (90 - 108%), making this a very promising alternative to the classical TEVA/TRU methods with the additional benefit of a more robust Am retention.

N. Vajda et al further examined the TK221 Resin with respect to Ac retention.

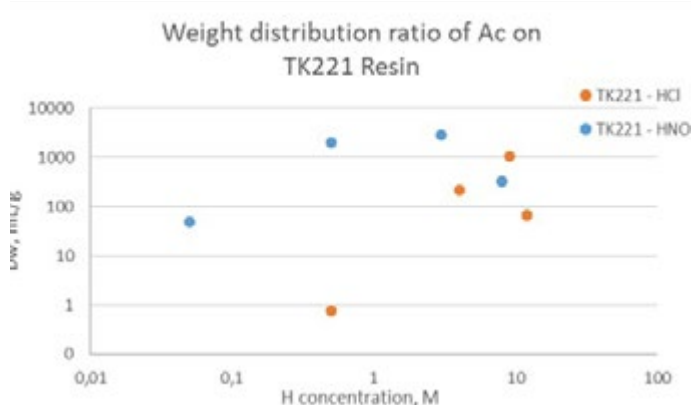

Weight distribution ratios (D_{Wj}) of Ac on TK221 Resin. Data courtesy of N. Vajda (RadAnal)

Overall, the D_{Wj} values for Ac are elevated in HNO₃, even at very high (e.g. 8 - 10M) or low (e.g. 0.05M) concentrations. In HCl Ac retention is high at elevated HCl concentrations (9M HCl) while decreasing significantly at higher and lower acid concentrations. Especially at low HCl concentrations Ac D_{Wj} values are very low, indicating suitable elution conditions.

The high retention of Ac over a wide HNO₃ concentration range could further be shown through elution experiments.

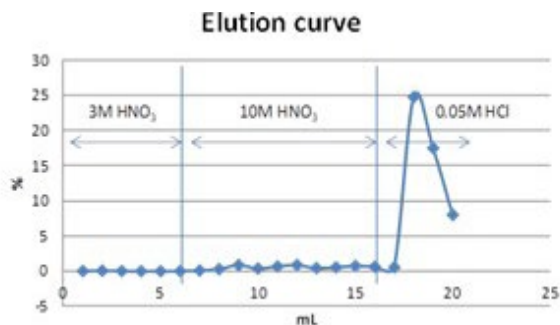

Ac elution study on 1 mL TK221 cartridge (100 - 200 μ m), 10M HNO₃ rinse. Data courtesy of N. Vajda et al.

Other than the DGA Resins the TK221 doesn't allow for Ac elution in 10M HNO₃, a step frequently used for Ac/Lanthanide separation. For TK221 even higher HNO₃ concentrations are required.

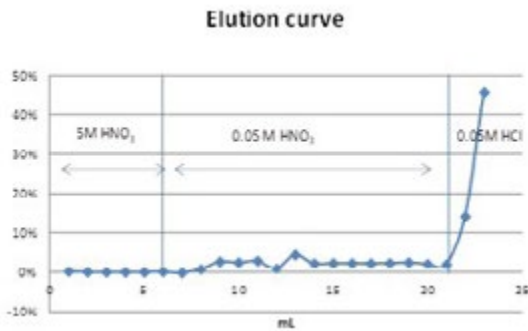

Ac elution study on 1mL TK221 cartridge (100 – 200µm), 0.05M HNO₃. Data courtesy of N. Vajda et al.

TK221 does not allow contrary to the DGA Resins Ac elution in dilute HNO₃.

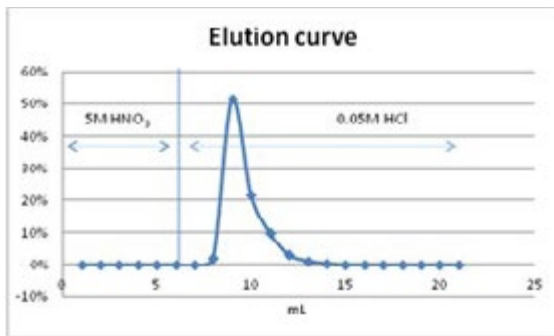

Ac elution study on 1mL TK221 cartridge (100 – 200µm), 0.05M HCl elution. Data courtesy of N. Vajda et al.

The fact that TK221 retains Ac from dilute HNO₃ and allows its elution in dilute HCl might open the possibility of converting Ac solutions from dilute HNO₃ to dilute HCl using TK221.

It should be noted that TK221 is now also available in 50 – 100µm particle size now, which should allow for narrower elution.

Overall, a separation method similar to Lu-177 purification seems possible: Ac retention from elevated HNO₃ (or HCl) rinse with dilute HNO₃ to remove impurities and lower HNO₃ concentration on the resin, followed by elution in HCl. Ideally the final product should be loaded through a small anion exchange resin cartridge (e.g. 1 mL A8) to remove last traces of nitrate.

Additional work on the Ac separation on TK221 Resin is currently on-going.



Main applications:

- Separation and concentration of lanthanides (e.g. ca and nca Lu-177)
- Separation of actinides
- Separation of actinium

TK211/2/3 Resins

The TK211, TK212 and TK213 Resins are based on different mixtures of organophosphoric, organophosphonic and organophosphinic acids. It could be shown that under certain conditions and for certain lanthanide pairs, such mixtures can show increased selectivity compared to the respective pure compounds.

The organic phase further contains a small amount of a long-chained alcohol that will act as radical scavenger to increase the radiolysis stability of the resin.

The inert support onto which the organic phase is impregnated contains aromatic groups which will also contribute to the increase of the radiolysis stability of the resins.

The inert support further shows an elevated capacity for the extractants. Accordingly, this allows the TK211/2/3 Resins to have a higher extractant load compared to e.g. the LN Resin series.

The TK211/2/3 Resins show, like the LN Resins differences in their respective acidities. TK211 is the most acidic resin, accordingly it will extract lanthanides, and other elements, at higher acid concentrations than e.g. TK212 and TK213. TK212 on the other hand is more acidic than TK213 [order of acidity: TK211 > TK212 > TK213].

The selectivity and retention of the lanthanides is generally very similar in HNO₃ and HCl on all three resins, accordingly both acids may be employed for the separation of lanthanides.

This difference in the relative acidity of the resins can be exploited to facilitate otherwise more complex lanthanide separations.

This will particularly be the case for the separation of very small amounts of one lanthanide from a large excess of its neighbouring lanthanide.

Typical examples are the production of nca Lu-177 [separation from irradiated Yb-176 targets] and nca Tb-161 [separation from irradiated Gd-160 targets].

By performing a first separation on a 'less acidic resin' such as TK212 followed by direct elution of the lanthanide fraction to be further purified onto a more acidic resin such as TK211 for further purification ("sequential separation") it is possible to eliminate intermediary steps such as the use of TK221 (or DGA) Resin to convert the lanthanide fraction from higher acid concentration to low acid concentration.

In an ideal case even a fully sequential three column separation might be possible (TK213 => TK212 => TK211).

Two examples of the use of such sequential separation steps will be shown in the following.

The production of nca Lu-177 is rapidly gaining importance due to its increased use in nuclear medicine. Reliable, preferably easy to automatize methods that allow for its separation from irradiated Yb-176 targets of elevated size (≥500 mg) are thus of increasing importance.

Horwitz et al. describe a method based on three LN2/ DGA cycles for the separation of nca Lu-177 from 300 mg Yb-176 targets. While this method gives good yields (~73%) in a short separation time (~4h) the fact that an elevated number of columns are required complicates its automatization. Further it has only been tested for up to 300 mg of target material.

By introducing a sequential separation step this method can be partially simplified.

It could be shown that the method described in the following figure allows for separating Lu from up to 500 mg of Yb with elevated Lu recovery (~85%) and a very low amount of residual Yb in the final Lu fraction.

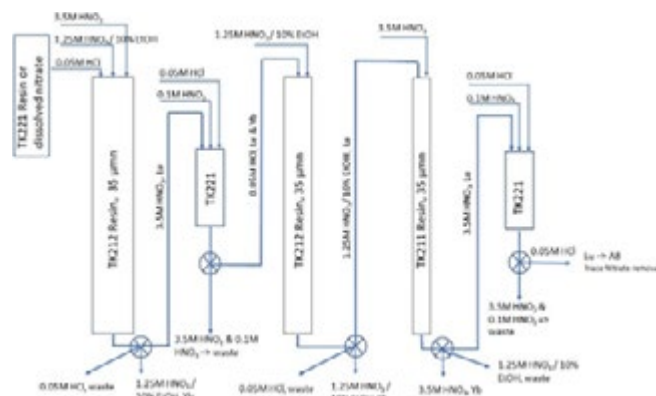

Scheme of a method for the separation of Lu from 500 mg Yb using TK212, TK221 and TK211

The increased Lu recovery is, other than the use of TK212 instead of LN2, also due to the adjustment of the eluting agent used for the chromatographic separation of Lu and Yb on the first TK212 column from 1.3M HNO₃, as suggested by Horwitz et al., to 1.25M HNO₃ / 10% EtOH.

It should be noted that adding EtOH only showed an improvement for the 1.25M HNO₃ but not for the 3.5M HNO₃. Further, mixing 3.5M HNO₃ with EtOH should be strictly avoided for safety purposes.

The following figures show typical chromatograms obtained during the separation of Lu from 500 mg of Yb (initial Lu:Yb ratio: 1:1000). All experiments were performed using stable elements, fractions of defined sizes were collected, diluted, and analysed off-line by ICP-MS. Relative recoveries were calculated for Lu and Yb and plotted against the elution volume.

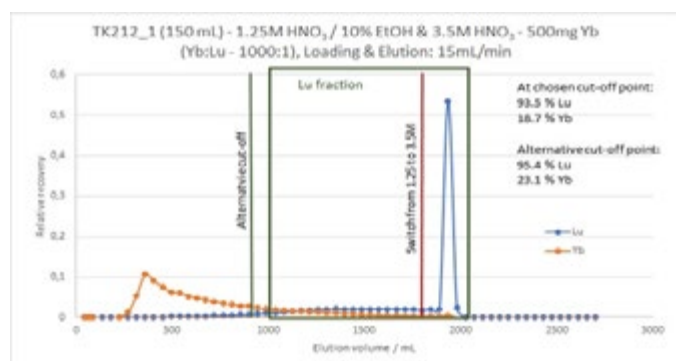

Example of a Lu separation from 500 mg Yb on a TK212 column (2.5 x 30 cm, 150 mL) using 1.25M HNO₃ / 10% EtOH and 3.5M HNO₃ e of a method for the separation of Lu from 500 mg Yb using TK212, TK221 and TK211

It should be noted that the switch to 3.5M HNO₃ in the given example was made at a rather late stage of the separation. In the final version of the process it should take place earlier, ideally triggered via radiation detection, close to the chosen cut-off point (left end of the green frame).

Indeed, the moment of the switch will have, especially on the first column, a considerable influence on the Lu recovery and Yb carry-over. This is mainly due to the significant tailing introduced by the macro-amount of Yb.

The fractions comprised in the green frame ("Lu fractions") were combined and passed through a 5g TK221 cartridge for conversion to ≤0.05M HCl. The Lu fraction thus obtained in dilute HCl was then loaded onto the next TK212 column (1.5 x 30cm, 53 mL).

Due to the lower of amount of Yb present on the column the tailing of the Yb and Lu elution is less pronounced than on the first TK212 column.

Although this would be possible, in this example the Lu containing fractions (green frame) are not eluted

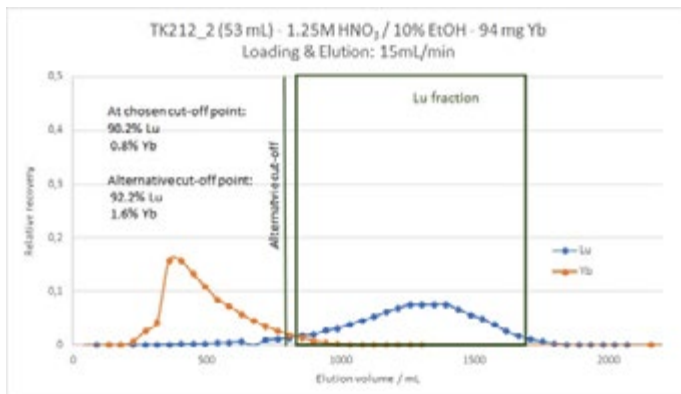

Example of a Lu separation fraction, obtained from a first TK212 separation from 94 mg Yb, on a second TK212 column (1.5 x 30 cm, 53 mL) using 1.25M HNO₃ / 10% EtOH

in HNO₃ of elevated concentration (as described in the Horwitz method), passed through a TK221 (or DGA) cartridge and eluted in dilute HCl for another load onto TK212.

Instead the combined fractions are directly loaded onto a TK211 column (1.1 x 30 cm, 29 mL) for the final purification of the Lu.

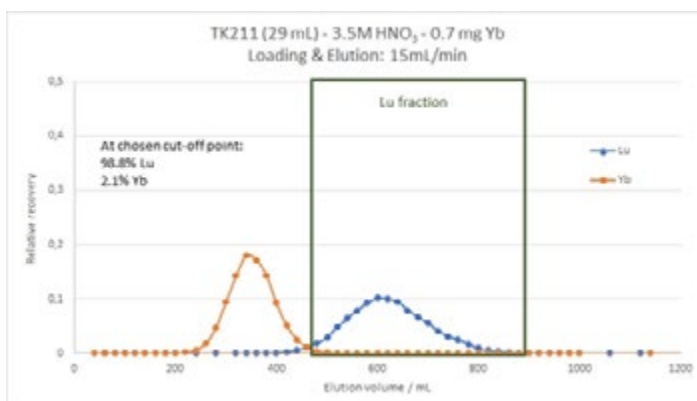

Example of a Lu separation fraction, obtained from the second TK212 separation from <1 mg Yb, on a second TK212 column (1.1 x 30 cm, 29 mL) using 3.5M HNO₃

Lu is finally obtained following separation/elution e.g. with 3.5M HNO₃.

As final step the obtained Lu fractions (as indicated in the green frame) were combined and loaded onto a 2 mL TK221 cartridge, any last potentially present impurities are removed through consecutive rinsed with 3.5M HNO₃ and 0.1M HNO₃. Lu is then finally eluted using ≤0.05M HCl.

Last traces of nitrates that might still be present will be removed via a 1 mL anion exchange cartridge (A8 Resin).

A further upscale of this separation process is currently being finalized.

Another radiolanthanide increasingly finding use is Terbium. As Tb isotopes may be used for PET imaging (Tb-152), SPECT imaging (Tb-155), alpha therapy (Tb-149) and beta therapy (Tb-161) it is also referred to as the 'swiss army knife' of nuclear medicine.

Particularly the interest in Tb-161 is currently increasing significantly, accordingly methods for the separation of Tb from irradiated Gd targets of elevated size are needed.

The upscale of methods for the separation of Tb from >1000mg Gd is currently on-going. The next figure shows a scheme of a suggested separation process.

As may be seen the separation is more straightforward compared to the separation of Lu from Yb targets.

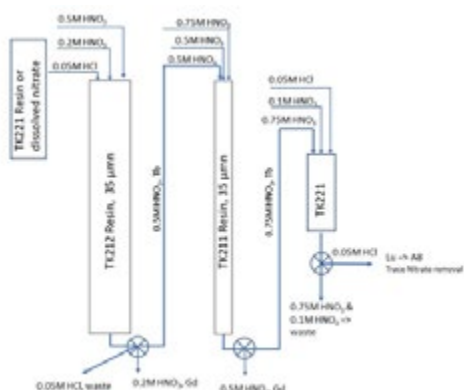

Scheme of a method currently under development for the separation of Tb from 1000 mg Gd using TK212 and TK211

The following two figures show typically obtained chromatograms (stable Gd, Tb and Dy, with an original ratio of 1000:1:1).

Like for the Lu separation the separations were performed using stable elements, fractions of defined volumes were taken and analysed by ICP-MS.

A first separation is performed on a TK212 column. This step allows for an initial separation of Tb from Gd and Dy.

The obtained Tb fractions (indicated by the orange frame) were then combined and directly loaded onto a TK211 column for final purification of the Tb.

As may be seen in the next figure under the chosen conditions most of the Gd is breaking through during the load, any Gd remaining on the columns is rinsed of with 0.5M HNO₃.

It could be shown for the Lu separation process that the addition of small amounts of EtOH (10% v/v) improves the separation, this is currently also being tested for the Tb separation.

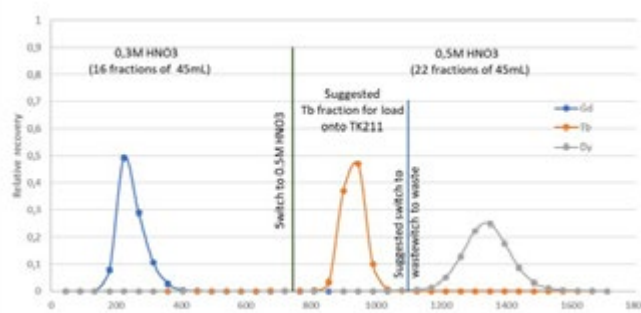

Example of a Tb separation from 1000 mg Gd on a TK212 column (2.5 x 30 cm, 150 mL) using 0.3M HNO₃ and 0.5M HNO₃

Increasing the concentration of the mineral acid (in this example to 0.75M HNO₃) will lead to the elution of Tb, leaving potentially remaining traces of Dy on the columns. In case the presence of Dy can be ruled out this elution can be performed at higher acid concentrations, thus lowering the elution volume.

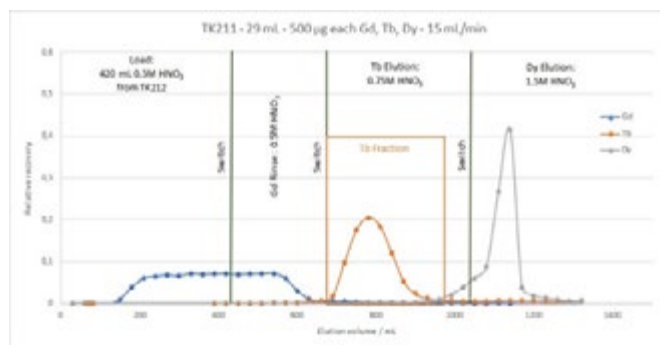

Example of a Tb separation from 500 µg Gd on a TK211 column (1.1 x 30 cm, 150 mL) using 0.5M HNO₃ and 0.75M HNO₃

As a final step the Tb will be concentrated on a 2 mL TK221 cartridge, any last potentially present impurities are removed through consecutive rinsed with 0.75M HNO₃ and 0.1M HNO₃. Tb is the finally eluted using ≤0.05M HCl.

Last traces of nitrates that might still be present will be removed via a 1 mL anion exchange cartridge (A8 Resin).

The indicated method is currently undergoing further optimisation and upscale.

Prepacked TK211/212/213 columns of various sizes (e.g. 150 mL, 53 mL and 29 mL) are currently being developed.



Main Applications :

- Lanthanide separation e.g. nca Lu-177 and nca Tb-161

TBP Resin

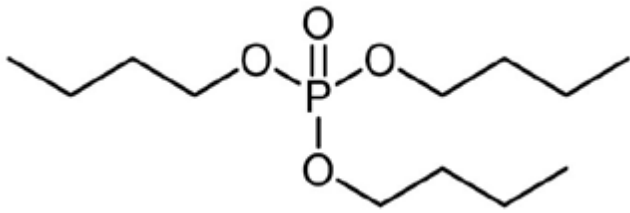

TriButylPhosphate (TBP)

The TBP Resin is comprised of an inert support impregnated with Tributylphosphate (TBP). TBP is a widely used extractant, it finds e.g. application in the Purex process, the reprocessing of U and Pu from spent fuel. Other applications include, amongst others, the separation of yttrium for analytical purpose.

The TBP Resin has been characterized with respect to the uptake of various elements in HNO₃ and HCl.

Beside Pu(IV) and Np(IV) several other elements such as Au, Zr, Hf, Fe, Sn and Ga also show high affinity for the TBP Resin in HCl.

While Au remains retained under all tested conditions, making its elution rather difficult in HCl, the other elements only show high D_w values at elevated acid concentrations, and low D_w values at lower concentrations.

In 1M HCl for example only Sn shows elevated D_w values whereas Fe, Ga, Sb... show very little affinity to the resin, allowing for its separation from these elements. Sn can then be eluted e.g. with 0.1M HCl.

The TBP resin generally shows very good selectivity for Sn over Te (Te-126 is an isobaric interference

for the mass spectrometric determination of a long-lived beta emitter Sn-126, frequently determined in decommissioning and radioactive waste samples) and over Cd which is frequently used as target material for the production of Sn-117m, a conversion electron emitter used in nuclear medicine.

The resin also shows interesting selectivity for Sb, however its oxidation state needs to be carefully controlled.

It has further been employed by Graves et al. for the separation of Zr-89 from Y targets. It is also used for the separation of Sc from Ca targets. In both cases the products were retained from high HCl and eluted in dilute HCl. Under similar conditions a Ga separation from Zn should be feasible.

In HNO₃ of all tested elements only the actinides (at elevated HNO₃ concentrations), and Ag (at low HNO₃ concentrations), are retained on the resin.

Based on the obtained data, Dirks et al. have developed a procedure for the separation of Sn from various elements.

Most of the tested elements are not retained during load and first rinse. Sn and part of the Ga and Fe are retained. The latter two are first removed with 1M HCl, Sn is then quantitatively eluted with 6 mL 0.1M HCl in high purity.



Main Applications :

- Separation of zirconium
- Separation of tin
- Separation of scandium
- Separation of actinides

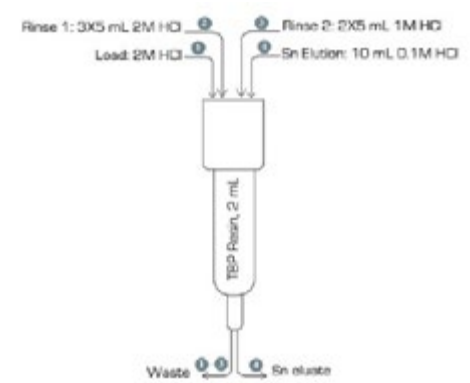
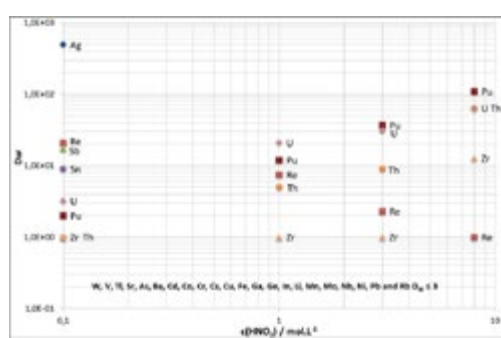
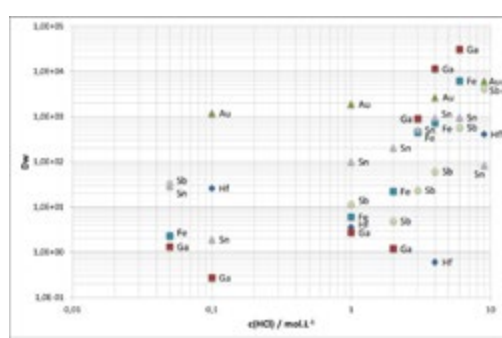

D_w values of selected elements on TBP Resin in HCl and HNO₃.

Separation scheme Sn separation on TBP Resin.

TK400 Resin

The TK400 Resin is an extraction chromatographic resin that is comprised of a long-chained alcohol impregnated onto an inert support. Knight et al. showed that long-chained alcohols, especially octanol, show very interesting selectivity towards Pa at high HCl concentrations, allowing for facile Pa/Np separation using column chromatography. Jerome and al. characterized the TK400 Resin with respect to its selectivity for

They found that Pa retention sharply increases at high ($\geq 9M$) HCl concentrations whereas other elements tested are not retained. At HCl concentrations $< 8M$ HCl on the other hand D_w values of Pa were found to be low allowing for its elution in a small volume. Ostapenko et al. found a similar trend for Pa retention with k' values being high for Pa at high HCl concentrations (9M). These results correspond overall well to the selectivity observed by Knight et al. when performing Np/Pa separation.

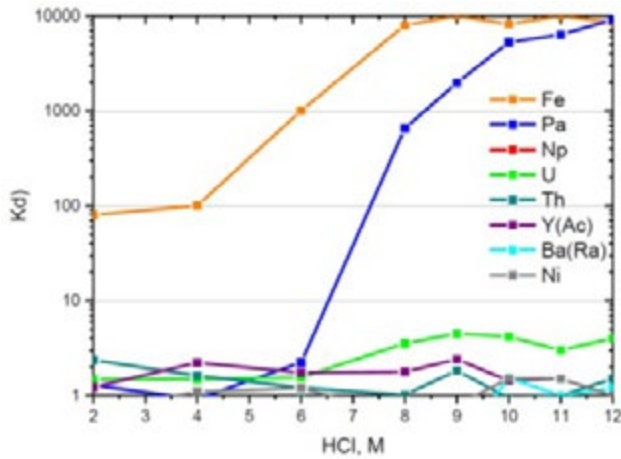

D_w values of selected elements on TK400 Resin in HCl at varying concentration [Data provided by Ivanov et al]

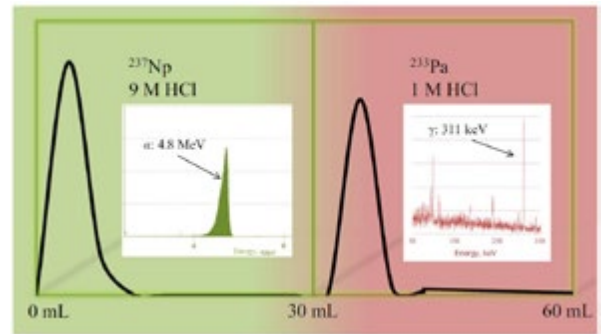

Elution study, Np/Pa separation on long-chained alcohol resin [Taken from Knight et al.]

The resin shows high selectivity for Nb at high HCl concentrations over other elements tested such as Ta, Zr, Hf and lanthanides which are not, or only very poorly as in the case of Ta, retained by the resin.

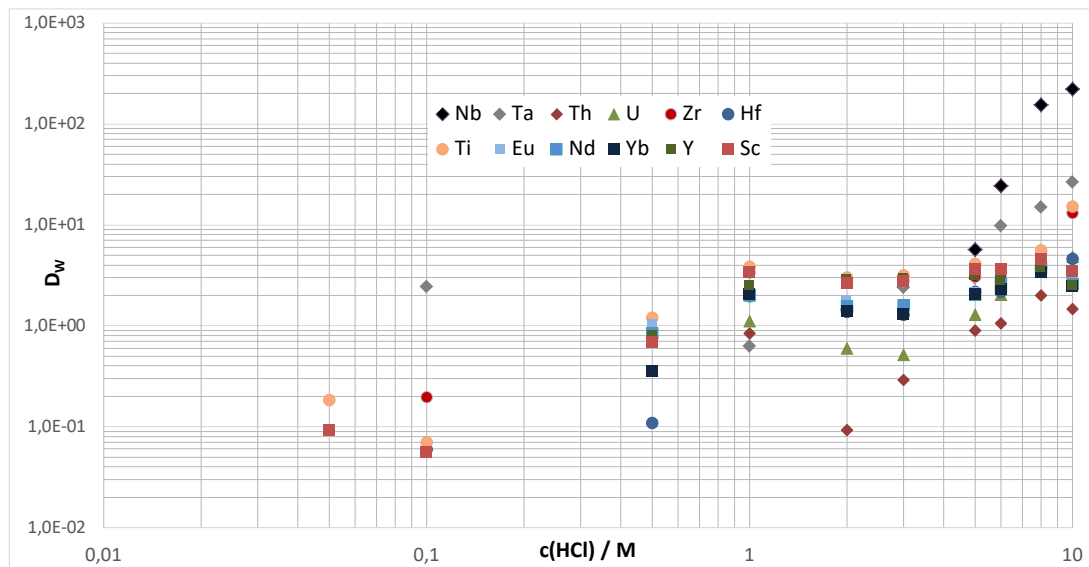

D_w values of selected elements on TK400 Resin in HCl at varying concentration

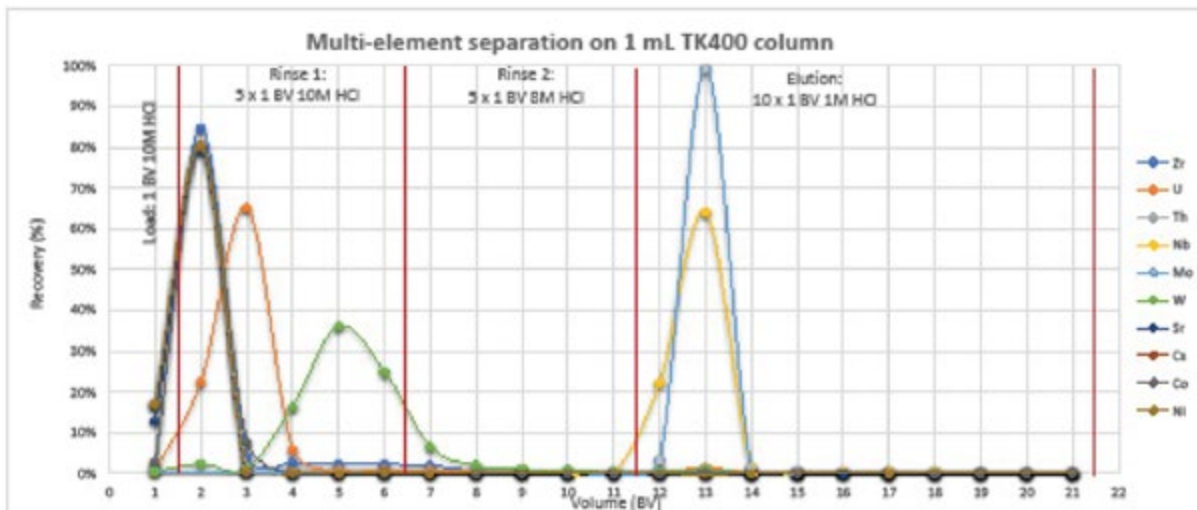

Elution study, Nb separation from selected cations, 2 mL TK400 column

With respect to its selectivity the TK400 Resin shows the potential for allowing a number of interesting separations such as Nb/Zr (see Nb separation scheme below) and Pa/U/Th (see Pa separation scheme below). The results of an elution study on the separation of Nb from a number of elements, including Zr, and the separation method used to obtain these results are shown in following figures. Jerome et al. employed the TK400 Resin for the separation of Pa from its descendants following the procedure shown here. They found that U, Th, Ac, Ra and Pb were removed from the resin during load and rinse, allowing for obtaining a clean Pa fraction with high chemical yield (~83%).

Another interesting application of the TK400 Resin was described by Tieu et al. and Svedjehed et al. Both authors used the TK400 for the separation of Ga-68 from irradiated solid Zn targets. Svedjehed et al. showed that it is advantageous for solid targets to use the TK400 instead of ZR Resin in combination with A8 and TK200.

The fact that the TK400 Resin shows higher Fe capacity than e.g. TRU Resin makes its use in the analysis of i.e. decommissioning samples interesting. A method combining the use of the TK400 Resin (separation of Fe, Nb and Mo from most matrix elements) and ZR Resin (subsequent separation of Fe from Nb and Mo) is currently being optimized. The following graphs show typically obtained elution profiles.

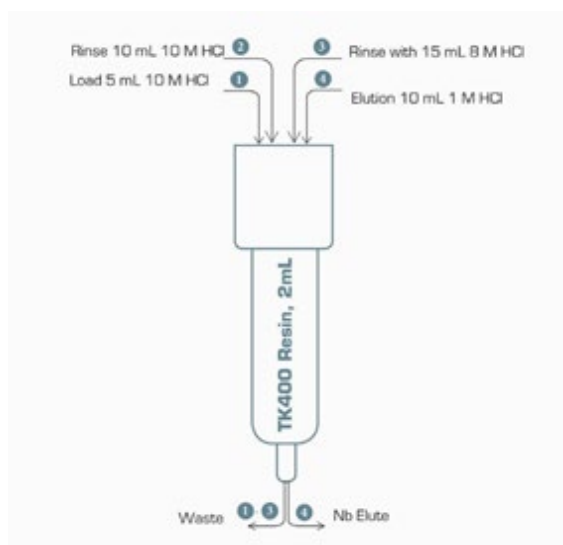

Nb separation on TK400 Resin

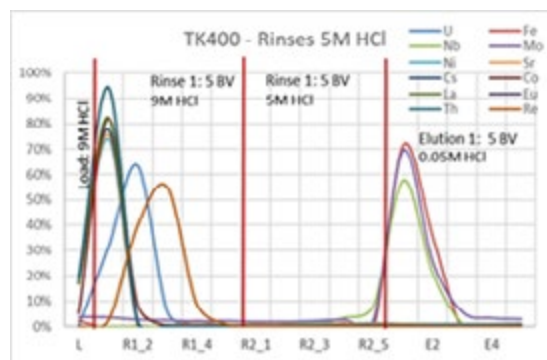

Fe/Nb/Mo separation from selected elements, TK400 Resin

As may be seen, while Fe, Nb and Mo are well retained a large number of other elements, such as e.g. Zr, U, Th, Cs, Co,... are removed during load and rinse. These three elements may then be eluted in dilute HCl and directly loaded onto ZR Resin for further separation.

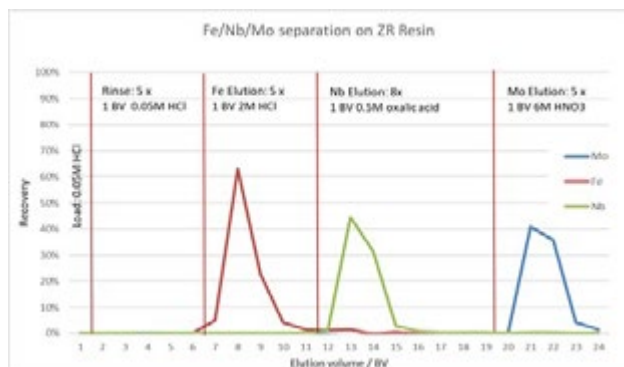

Fe, Nb and Mo separation on ZR Resin

The fact that the TK400 Resin shows high selectivity for Fe and Nb but not for Zr may also allow its use in the separation of Zr-89 from solid Y targets, with the aim to further lowering the amount of these impurities in the final product.

First tests showed that loading a simulated dissolved target solution containing Zr, Y, Nb and Fe through a TK400 Resin cartridge at 9M (or 10M) HCl, followed by a rinse under the same conditions will allow retaining Nb and Fe on the TK400 while Zr (and Y) will pass through. Combining the load and rinsing fractions containing Zr, adjusting them to 11M HCl and loading this solution through a TBP Resin cartridge (similar to the method described by Graves et al.) will then allow a clean Zr separation with high chemical yield. It should be noted that alternatively 10M HCl may be used as loading condition on both cartridges. This could simplify the separation, as the intermediate HCl concentration adjustment is not necessary. It might further allow for the use of stacked cartridges in the initial loading step, this modification will require further testing though. Zr is finally eluted from the TBP cartridge using dilute HCl.

If desired, Nb and Fe may be recovered from the TK400 cartridge using dilute HCl. The graphs below show typically obtained elution studies under the described conditions.

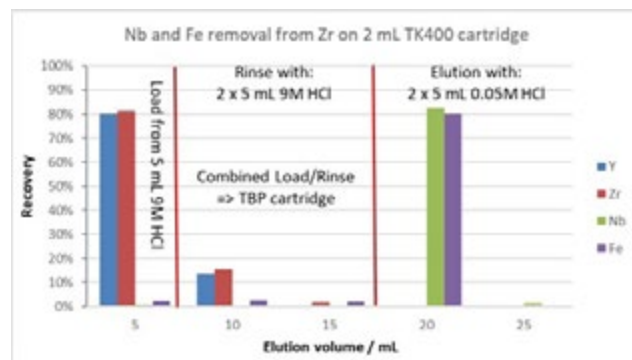

Nb and Fe removal from Zr (and Y) on a 2 mL TK400 Resin cartridge

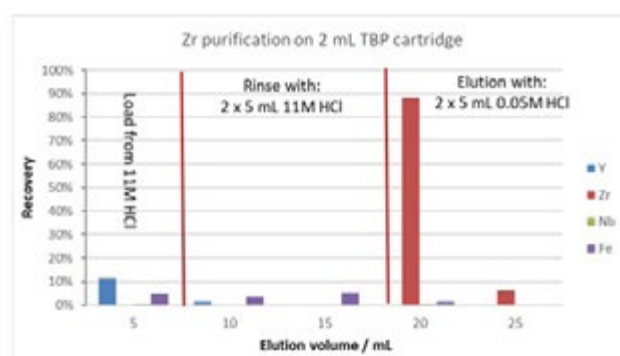

Zr purification on a 2 mL TBP Resin cartridge



Main Applications :

- Separation of protactinium
- Separation of gallium
- Separation of niobium
- Separation of iron

TK101 Resin

The TK101 Resin is based on the same crownether that is also used in the SR, PB and TK102 Resin. As diluent an ionic liquid is employed, this leads to a quite significant change in its selectivity at low acid concentrations, as can be seen in the following graphs.

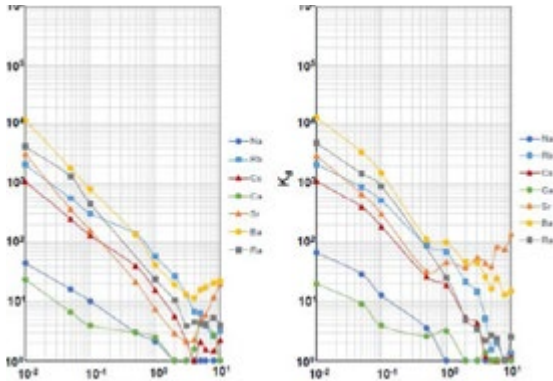

D_w values of selected elements on TK101 in HNO_3 . Data courtesy of Ben Russel (NPL)

While SR, PB and TK102 Resins show no selectivity for Sr, Ba, Ra at low acid concentrations TK101 does. In dilute HNO_3 as well as in HCl Ba, Ra and Sr are very well retained from $\leq 0.01M$ to approx. $0.05M$. Their retention decreases significantly as the acid concentration increases though. Sr retention in HNO_3 is an exception as it shows increasing retention at HNO_3 concentrations $> 3M$. It should be noted that, while Ra and Ba behave similar at lower acid concentrations, they do show differences at higher acid concentrations, notably at $3M HNO_3$, where the K_d Ba is higher than the K_d Ra, thus allowing for a Ra/Ba separation.

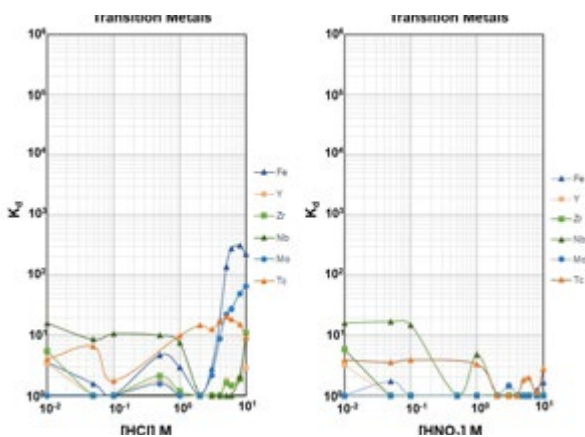

D_w values of selected elements on TK101 in HNO_3 . Data courtesy of Ben Russel (NPL)

Pb is very well retained over the whole HNO_3 concentration range. It is also very well retained from HCl up until approx. $3M HCl$. It's retention then decreases very sharply as the HCl increases, making HCl of high concentration suitable for Pb elution. Out of the elements shown in the graph above only Bi is also retained, particularly from dilute HCl at elevated

acid concentrations. It can be very easily removed though, especially using HNO_3 . Lanthanides and actinides are not retained on TK101 not in HCl neither in HNO_3 .

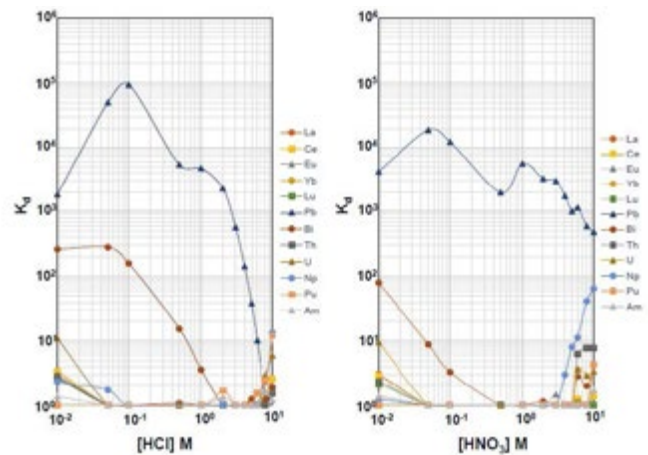

D_w values of selected elements on TK101 in HNO_3 . Data courtesy of Ben Russel (NPL)

Out of the tested transition metals only Nb shows some retention at high HCl, all other elements tested show very low K_d values. The graph below shows the result of an elution study performed with amongst others Th, Ce, Pt, Ir, Ba, Ra and Pb.

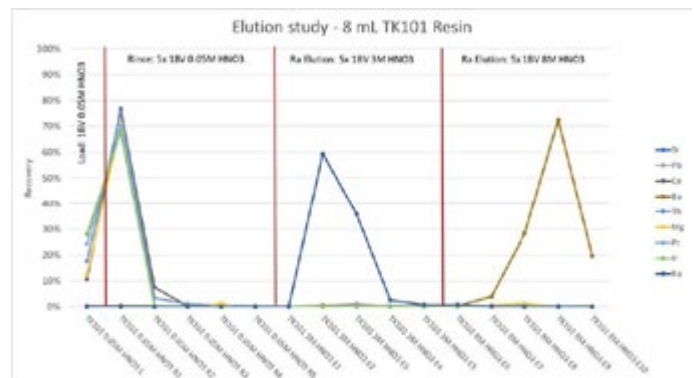

Elution study of selected elements on TK101. Ra data courtesy of Nora Vajda (RadAnal)

Other elements tested than Ba, Ra and Pb are removed during load and rinse with dilute acid (here $0.05M HNO_3$). Ra is then eluted with $3M HNO_3$, while Ba and Pb remain retained. Ba is eluted with $8M HNO_3$. Pb is still retained under these conditions and may then be eluted with $6 - 8M HCl$ or citrate/citric acid.

Main Applications :

- Ra separation
- Pb separation.

TK102 Resin

The TK102 Resin is based on the same crown-ether that is also used in the SR and PB Resin.

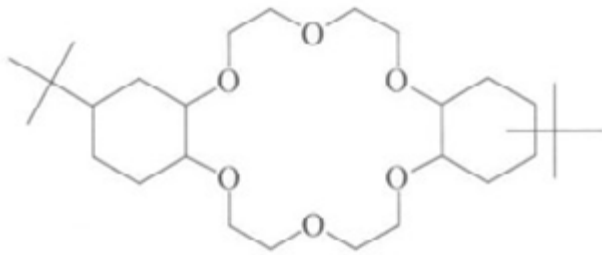

4,4'-(5'-di-t-butylcyclohexano-18-crown-6

Other than these resins the TK102 Resin contains a long-chained fluorinated alcohol as diluent. The resin further contains a larger amount of the crownether compared e.g. to the SR Resin. Further the organic phase is impregnated onto an inert support containing aromatic groups for increased stability against radiolysis.

The resin was originally optimized for the separation of Ba and Ra, how ever it also shows very interesting properties with respect to Sr and Pb separation.

The following two graphs show the selectivity of the TK102 Resin for a range of elements in HNO₃ and HCl. The third graph shows the influence of increasing amounts of Na, K and Ca on the Sr retention in 3M HNO₃.

All D_w shown in these graphs were obtained through ICP-MS measurements.

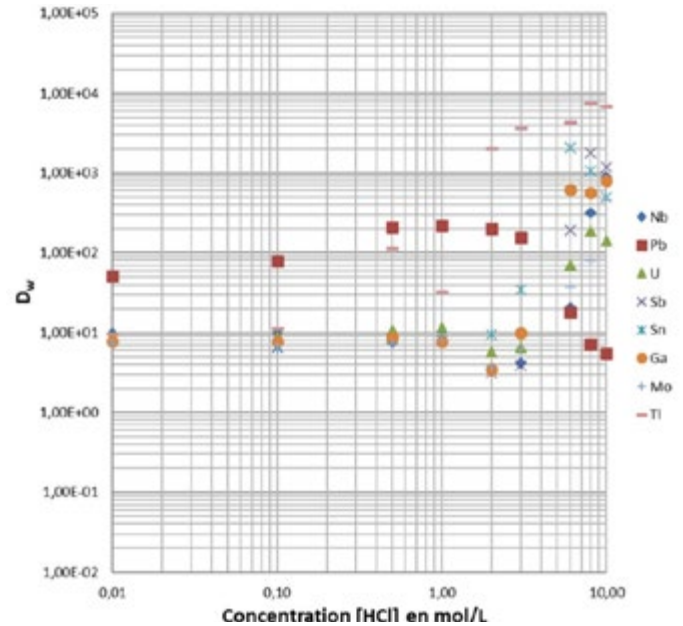

D_w values of selected elements on TK102 in HCl

As expected, Pb is well retained over a wide HCl concentration range, from dilute HCl up to 2 – 3M HCl. Pb DW values drop strongly for higher HCl concentrations (≥6M HCl), allowing for its elution under these conditions. The TK102 Resin retains, to a certain extent similar to the TK400 Resin, a number of elements at very elevated HCl concentrations, including Tl, Sb, Sn, Ga and Nb.

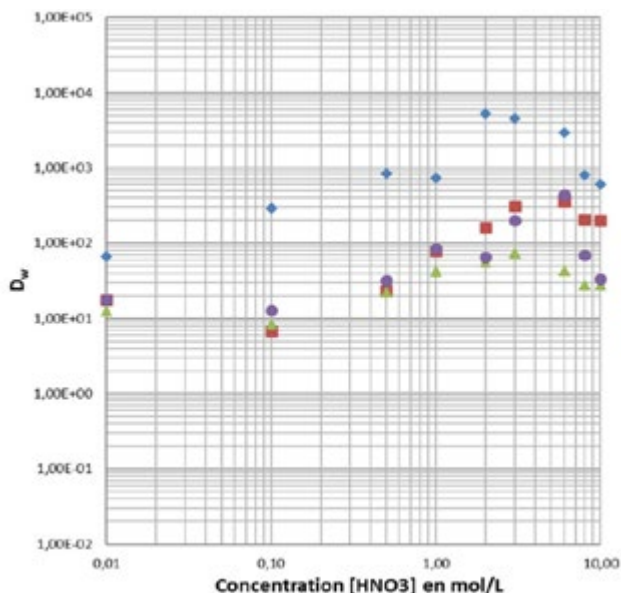

D_w values of selected elements on TK102 in HNO₃

Pb is very well retained over the whole HNO₃ concentration range. Sr is well retained at elevated HNO₃ concentrations (3 – 10M HNO₃), showing higher Sr D_w values than the SR Resin under these conditions. The same is true for Ba at 3M HNO₃, TK102 shows stronger Ba retention than SR Resin

Further it is notable that Tl is strongly retained from 3 – 6M HNO₃.

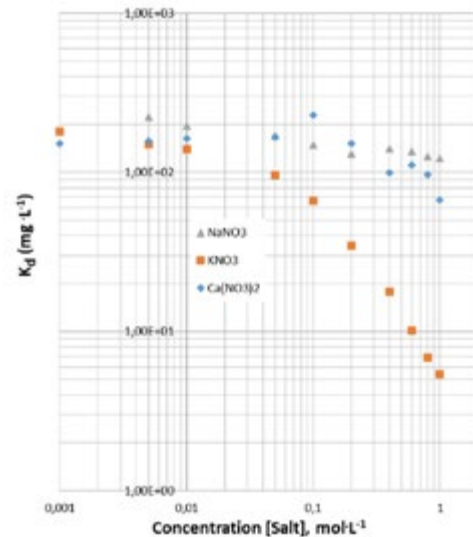

D_w values Sr on TK102 in 3M HNO₃ and in presence of increasing amounts of Na, K and Ca

Na shows very little influence on the Sr retention on the TK102 Resin, even at concentrations up to 1M D_w values for Sr remain high. Ca is showing a higher impact, nevertheless even at concentrations up to 0.5M Sr shows elevated D_w values.

As expected, K is interfering with the Sr retention very strongly, even concentrations ≥0.05M will lead to a significant decrease in Sr retention.

Just like for the SR Resin, performing a co-precipitation

e.g. with calcium phosphate) to remove K before the actual separation on TK102 Resin is crucial.

The following figures are showing three comparative elution studies on TK102 Resin and SR Resin.

The first example is a typical Pb separation based on loading from 2M HCl, Po removal with dilute HNO₃ and finally Pb elution with citrate.

Both resins are showing very similar elution profiles, TK102 Resin might require a slightly larger elution volume for Pb though. Nevertheless, typically employed elution volumes (e.g. 10 mL) should assure quantitative elution of Pb also from TK102.

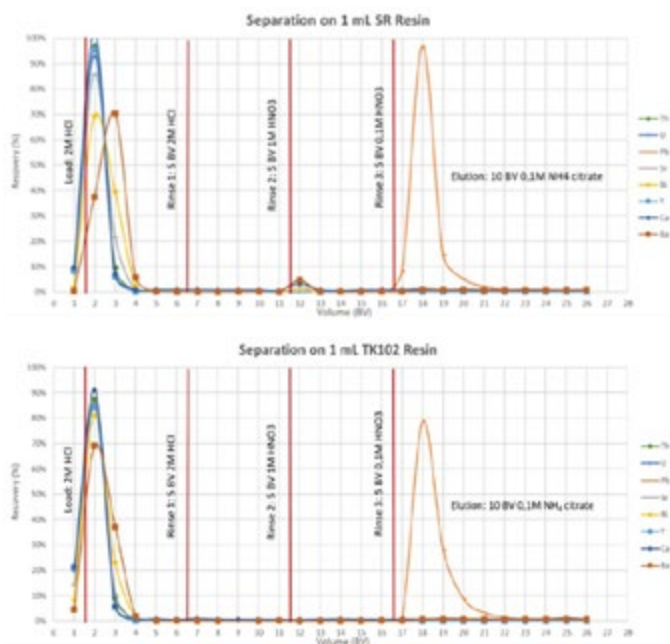

Comparative elution studies, SR and TK102 Resin, Pb separation

The second example is a typical Sr separation based on loading from 3M HNO₃, rinsing with 8M HNO₃ and 3M HNO₃/0.1M oxalic acid, and finally Sr elution in 0.05M HNO₃.

Again, both resins are showing similar elution profiles. One distinct difference being Th, for the TK102 Resin 3M HNO₃/0.1M oxalic acid rinse is required to remove most of the Th while on SR Resin the majority is already removed with 8M HNO₃.

Like for the Pb separation Sr elution from TK102 seems to require slightly larger volumes, but here too typically employed elution volumes (10 - 15 mL) seem to assure quantitative Sr elution.

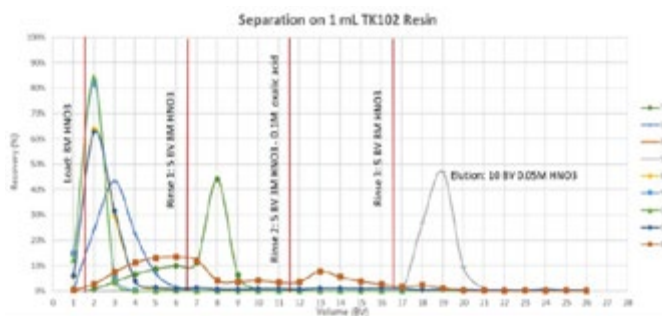
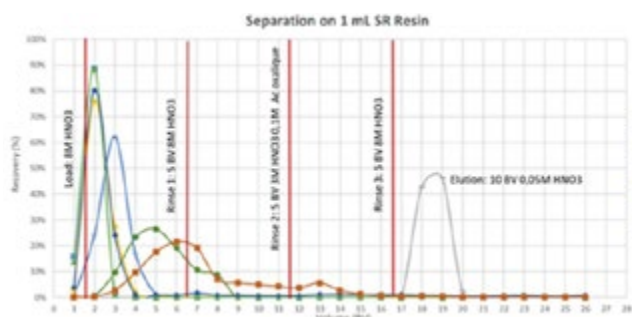

Comparative elution studies, SR and TK102 Resin, Sr separation

The third example shows a comparative Ba/Ra separation elution study. TK102 and SR Resin were both loaded from 3M HNO₃, then both resins were rinsed with several bed volumes (BV) of 3M HNO₃.

For both resins Ra is eluted quickly during load and first rinsing steps, while Ba remains retained.

On the SR Resin Ba starts to significantly break through after 6 BV, on the TK102 Resin the Ba retention is distinctively stronger, it starts to very slowly elute after about 8 - 9 BV.

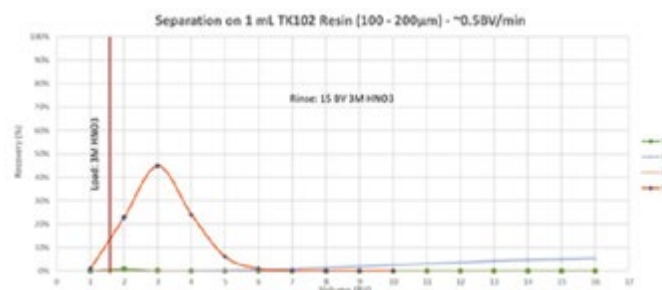
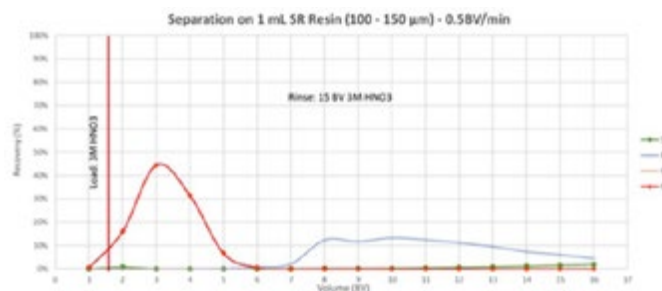

Comparative elution studies, SR and TK102 Resin, Ba/Ra separation

Further the TK102 Resin shows high dynamic capacity for Sr (>40 mgg⁻¹) and Pb (>90 mgg⁻¹).

Due to the higher hydrophobicity of the diluent employed in the TK102 Resin it also shows significantly (>10 times) less bleeding of organic material, measured as Non-Purgeable Organic Carbon (NPOC), than the SR Resin.

Main Applications :

- Ra/Ba separation
- Sr separation
- Pb separation

TK225 Resin

The TK225 Resin is based on a mixture of a diglycolamide and an ionic liquid. The organic phase is impregnated onto an inert support containing aromatic groups for increased stability against radiolysis.

The main application of the TK225 Resin is the removal of radiolanthanides from acidic solutions, particularly from solutions of elevated HNO_3 concentration, for decontamination purposes.

The following graphs show the selectivity of the TK225 Resin for a wide range of elements in HNO_3 and HCl . All D_W shown in these graphs were obtained through ICP-MS measurements.

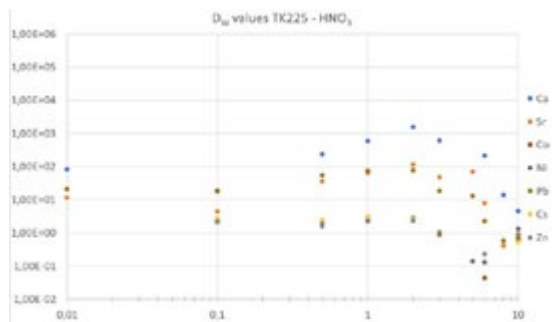

D_W values of selected elements on TK225 in HNO_3

Out of the tested elements only Ca is quite strongly retained at elevated HNO_3 concentrations. Sr and Pb, too are retained under these conditions to a lesser extent though.

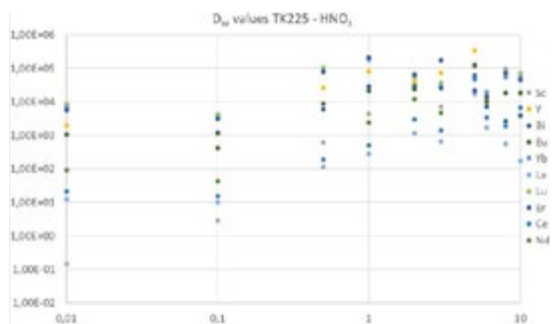

D_W values of selected elements on TK225 in HNO_3

Lanthanides, especially heavy lanthanides, Y and Sc are very strongly retained from HNO_3 of elevated concentration. Especially for heavy lanthanides the D_W values remain very high, even at low HNO_3 concentrations.

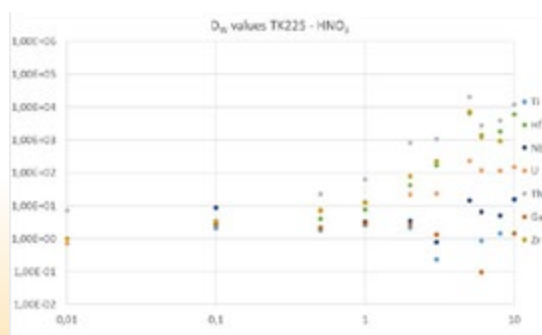

D_W values of selected elements on TK225 in HNO_3

The TK225 Resin generally retains tetravalent elements such as Zr, Hf and Th at elevated HNO_3 concentrations quite strongly.

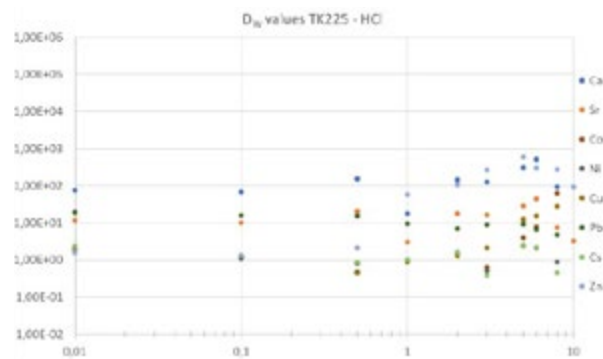

D_W values of selected elements on TK225 in HCl

The TK225 Resin shows elevated retention of Ca and Zn at high HCl concentrations. Other elements shown are not or only very weakly retained.

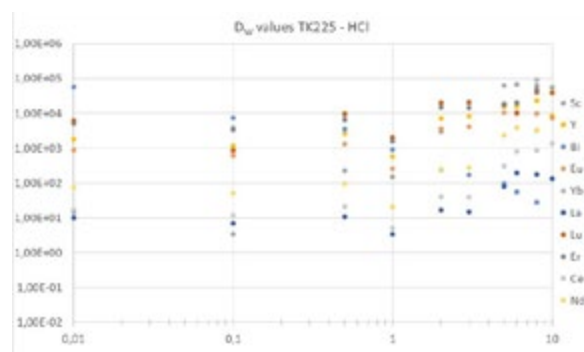

D_W values of selected elements on TK225 in HCl

Especially heavy lanthanides are well retained over a broad HCl concentration range, with highest retention being observed at high HCl concentrations.

At high HCl concentrations Y, Sc and lighter lanthanides are well retained, too.

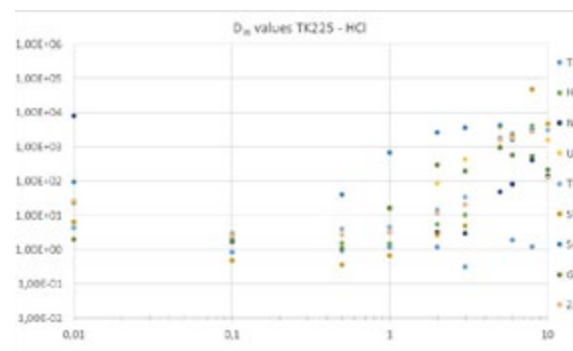

D_W values of selected elements on TK225 in HCl

Higher valent elements such as Sb, Sn, Zr and U are well retained at high HCl concentrations, while showing very little retention at low HCl concentrations. TK225 Resin is mainly used for the removal of radiolanthanides, especially heavy radiolanthanides such as Lu-177, Yb-175, Tb-161,... from acidic solutions.



Main Applications :

- Lanthanides removal from acidic effluents

Guard Resin

The Guard Resin is a hydrophobic, highly crosslinked, porous polydivinylbenzene based adsorbent. Due to its high hydrophobicity it will remove certain organic impurities, notably organic impurities that are hydrophobic, more efficiently than e.g. the Prefilter Resin. The Guard Resin is generally used in reversed phase chromatography and solid phase extraction, and for the adsorption of biomolecules of up to 14 kDa. It has a surface area of $> 600 \text{ m}^2/\text{g}$ and a typical porosity in the order of $300 - 500 \text{ \AA}$. The resin shows high mechanical and chemical stability, and it may be used over the whole pH range.

Another application of the Guard Resin is the separation, in combination with the ZR Resin, of Ge-68 from GaNi or GaCo targets. The actual separation of Ge from the target material is performed on two consecutive ZR Resin cartridges. The Guard Resin may then be used in the final step of the purification, namely the conversion of final product Ge-68 from dilute citric acid to dilute hydrochloric acid.

The Guard Resin is TSE/BSE/GMO free.



Main applications:

- Removal of organic impurities
- Ge-68 (in combination with ZR Resin)

TK202 Resin

The TK202 Resin is based on Polyethyleneglycol (PEG) groups, with high molecular weight, that are covalently bound onto a polymer support.

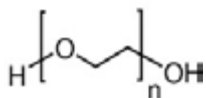

PolyEthyleneGlycol (PEG).

The TK202 Resin is based on an aqueous biphasic system (ABS) extraction mechanism with the covalently bound PEG acting as solid separation support. In presence of aqueous solutions with high ionic strength and high content of water-structuring (kosmotropic) anions like SO_4^{2-} , CO_3^{2-} , OH^- , as well as MoO_4^{2-} or WO_4^{2-} , it will extract chaotropic ions, according to Spear et al. notably TcO_4^- and ReO_4^- , while other non-chaotropic elements will not be retained, molybdenum being an important example.

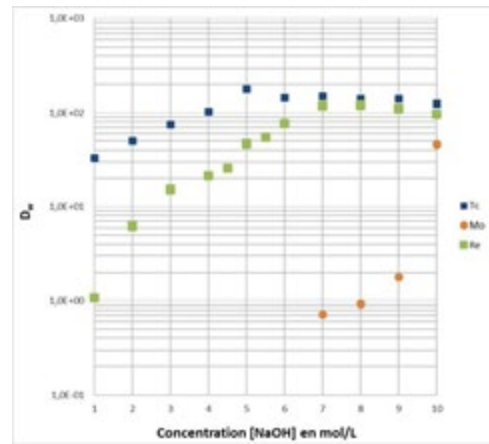

D_w values for Tc, Re and Mo on TK202 Resin, at varying NaOH concentrations. Tc data taken from Cieszykowska et al.

Accordingly, Tc (and Re) retention will improve with increasing concentration of these anions. The graph above shows D_w values for Tc, Re and Mo on TK202 Resin at increasing OH concentrations.

Ideally the NaOH concentration should be between 5 and 7M NaOH during load and rinse, as Tc (and Re) retention is highest while Mo retention is very low.

As mentioned before, MoO_4^{2-} itself is a kosmotropic anion. Accordingly, increasing its concentration will lead to higher Tc (and Re) retention in ABS systems like the TK202 Resin, as shown below. A distinct increase of the Tc retention with increasing amounts of Mo is observed.

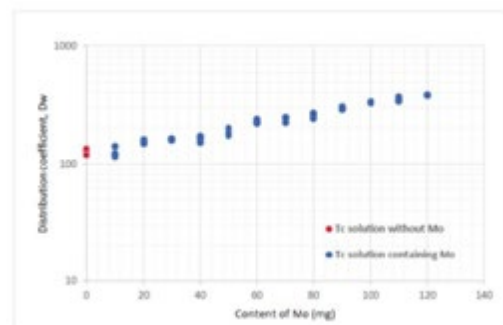

D_w values for Tc in 5M NaOH using 40 mg TK202 Resin, increasing amounts of Mo. Data taken from Cieszykowska et al.

This is particularly relevant in case of the separation of Tc from elevated amounts of Mo (e.g. irradiated Mo targets).

Cieszykowska et al. estimated from column studies that 6 to 8g of Mo per g of TK202 Resin allow obtaining high Tc recovery ($> 90\%$). Further increasing the amount to 12g Mo/g of resin lead to a decrease of the Tc recovery to $\sim 82\%$ in their experiments.

The retained Tc and Re can then be eluted with water as the ABS systems breaks down, due to the low concentration of kosmotropic anions, under these conditions.

As mentioned, one potential application of the TK202 Resin is the separation of Tc-99m from irradiated Mo targets. Accordingly, its high selectivity for Tc over Mo, and the fact that the presence of elevated amounts of Mo in solution increases the Tc retention, makes the TK202 Resin particularly suitable for this type of applications.

Indeed, besides the production of Mo-99 for the fabrication of Mo-99/Tc-99m generators via U-235 fission there are a number of other ways to produce Mo-99, and thus Tc-99m. Three of these methods are based on the irradiation of Mo targets:

- Neutron activation of Mo-98 via (n, γ) reactions (Mo-98 (n, γ) Mo-99), preferably performed in a reactor with high neutron flux.
- Photon-induced (γ, n) reaction of Mo-100 (Mo-100 (γ, n) Mo-99) using photons (γ) obtained through irradiation of heavy targets (converter) e.g. with electron beams.
- Direct Tc-99m production on a cyclotron using Mo-98 targets (Mo-98 $(p, 2n)$ Tc-99m). This latter method represents, with respect to the short half-life of Tc-99m, certain logistical challenges and will generally rather allow for supplying users close to the production facility. This method requires a clean, and very rapid, separation of the produced Tc-99m from the target material.

The first two described methods tend to result in Mo-99 of limited specific activity, especially compared to Mo-99 obtained from U fission. Accordingly using them e.g. in alumina column based generator systems will, due to the generally limited Mo capacity of these columns, result in rather lower activity Mo-99/Tc-99m generators.

In such cases employing a resin, such as the TK202 Resin, to extract the Tc-99m originating from Mo-99 decay while letting Mo pass through ("inverted generator") is often a preferred option.

It should be noted that in all three cases the recovery and recycling of the enriched Mo is of very high importance due to the pricing and limited availability of the target material.

The production methods described above all require the use of a resin with high selectivity for Tc over large amounts of Mo. Ideally, as the Mo targets are very frequently dissolved in NaOH solutions of elevated concentration, the resin should show this selectivity under these conditions.

This is the case for the TK202 Resin. As indicated before, Tc may then be recovered using water, although further separation steps will be necessary to adjust pH and Na^+ concentration of the final product.

Initial elution studies using Re instead of Tc confirmed the high selectivity for Re (and, as could be confirmed in separate tests, also Tc) over Mo.

The graph below shows an elution study performed with trace amounts of Mo and Re. As it can be seen, a clean separation of both elements is obtained. Mo is removed during load and following rinses (both may be performed with 5 - 7M NaOH), while Re elutes in a small water volume.

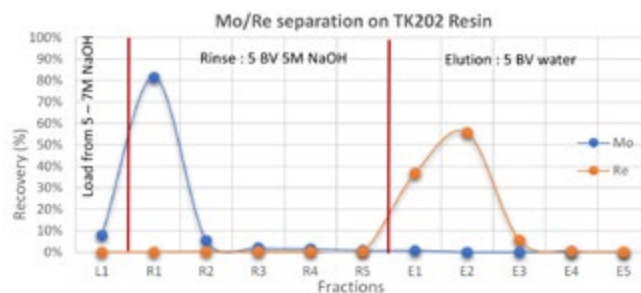

Elution study, trace amounts of Mo and Re on a 2 mL TK202 Resin cartridge, load and rinse at 1 BV/min, elution at 0.25 BV/min.

As the general selectivity could be confirmed further tests were performed using larger amounts of Mo.

The elution study below shows the separation of traces of Re from 2g of Mo, as e.g. typically required in case of Tc-99m production from Mo-98 irradiation in a cyclotron, as described e.g. by Bénard et al. Elution study, separation of trace Re and 2g Mo on a 2 mL TK202 Resin cartridge, load and rinse at 1 BV/min, elution at 0.25 BV/min.

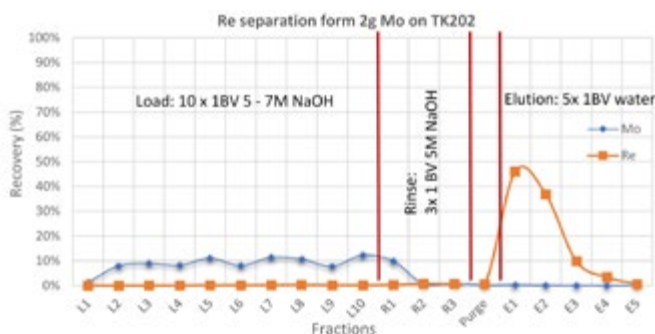

Elution study, separation of trace Re and 2g Mo on a 2 mL TK202 Resin cartridge, load and rinse at 1 BV/min, elution at 0.25 BV/min.

It should be noted that purging the resin, e.g. with air, after the rinse and before its elution with water, to remove NaOH from the cartridge/column, is of high importance to reduce the Na⁺ and OH⁻ load of the final Tc/Re fractions.

It could further be shown that lower flow rates during the elution of the TK202 Resin will result in narrower elution peaks, and thus lower elution volumes.

As discussed previously, the TK202 Resin may also be used to extract Tc-99m from Mo-99 decay present in an alkaline solution. In such cases much larger Mo targets are generally irradiated.

With respect to this, the separation of trace of Re from 100g Mo was tested. As shown below a clean separation of Mo and Re could be obtained here, too. Nevertheless, with respect to the very large amount of Mo present, an additional purification of the obtained Tc will be required.

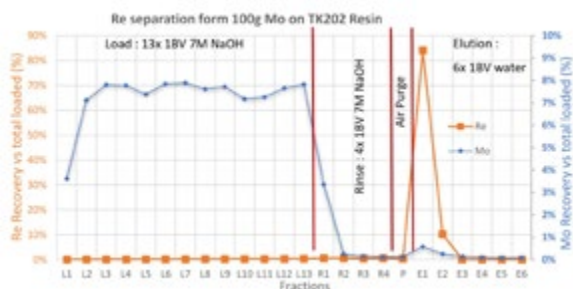

Elution study, separation of trace amounts of Re and 100g Mo on a 75 mL TK202 Resin cartridge, load at 0.5 BV/min, rinse at 1 BV/min, elution at 0.2 BV/min.

Elution study, separation of trace amounts of Re and 100g Mo on a 75 mL TK202 Resin cartridge, load at 0.5 BV/min, rinse at 1 BV/min, elution at 0.2 BV/min.

Methods for the separation of Tc from larger Mo amounts (e.g. ≥200g) are currently being tested.

As shown e.g. by Bénard et al., one convenient option for this additional Tc purification is the use of a cation exchange resin (for Na⁺ removal and pH adjustment to below pH 7), followed by an alumina cartridge (for Re/Tc concentration and further Mo removal).

Especially for the cation exchange cartridge it is important to adjust the size of the cartridge to the amount of Mo previously present in the sample/and so the size of the TK202 Resin cartridge employed.

For the size of the alumina cartridge on the other hand the amount of residual Mo will be a decisive

parameter.

The graph below shows the continuation of the 2g Mo separation test shown before.

The obtained Re fractions (E1 – E4) were combined and loaded through a C8 cation exchange resin cartridge which was then rinsed with water. The load fractions and the first rinse were collected, analyzed, and then combined for the final step of the

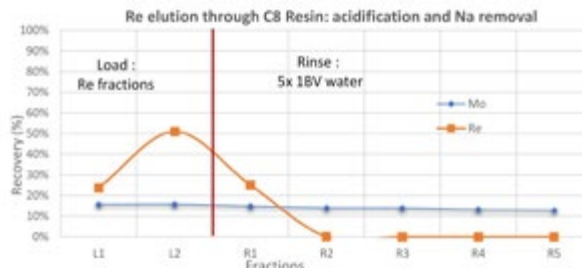

Continuation of the separation of Re from 2g Mo (see above). Na⁺ removal and pH adjustment of Re fractions on 2 mL C8 Resin cartridge, load and rinse at 2 BV/min.

Continuation of the separation of Re from 2g Mo (see above). Na⁺ removal and pH adjustment of Re fractions on 2 mL C8 Resin cartridge, load and rinse at 2 BV/min.

As stated before, at this stage the Re fraction should be below pH 7 (typically 3 – 5) and largely free of Na⁺ cations.

It could be shown that under these conditions, acidic alumina will retain Re/Tc (and Mo). A 0.9% NaCl solution then allows eluting Re/Tc in a small volume (2 – 3 BV) while Mo remains very strongly retained, thus further improving the purity of the recovered Re/Tc.

The indicated air purge is not necessary in case of the AlOx Resin (acidic alumina).

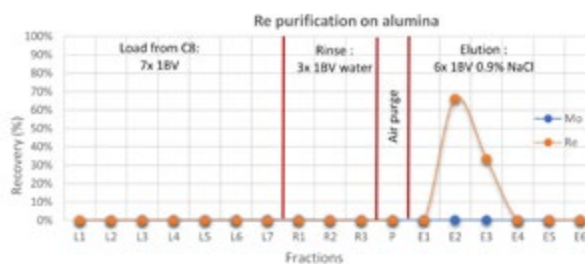

Re concentration, purification and conversion to 0.9% NaCl solution on 1 mL AlOx Resin at 2 BV/min.

This further has the advantage of allowing to obtain the Tc in the same matrix (0.9% NaCl) as delivered by a Mo-99/Tc-99m generator.

Overall, in the cold tests Re recoveries in the order of >90% could be obtained.

A schematic overview of the suggested separation method is given below. The method may be applied for the separation of Tc from Mo targets of various sizes, cartridge/column volumes will need to be adjusted accordingly.

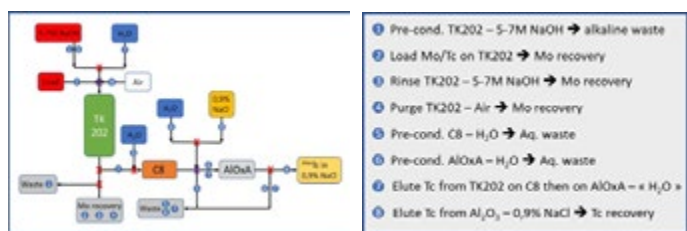

Schematic overview, Tc separation from Mo.

Further to the TK202 Resin TrisKem also supplies C8 Resin, AlOxAl Resin.

All resins are available in various columns and/or cartridges of different sizes (depending on the size of the Mo target).

Please contact us for further information.

Besides the described radiopharmaceutical use the TK202 Resin may also be employed in radioanalytical applications, notably in the analysis of Tc-99 in samples that were solubilized via alkaline fusion.

In such cases the solubilized samples (e.g. concrete samples resulting from decommissioning work) may, after removal of insoluble material, be adjusted to 5 - 7M NaOH and then passed through TK202 Resin to separate Tc.

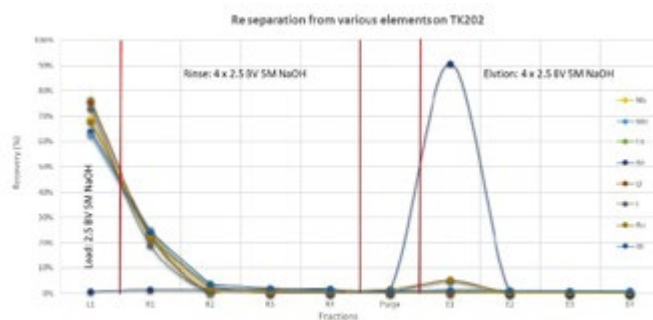

Re separation from selected elements on 2 mL TK202 Resin cartridge, load and rinse at 1 BV/min, elution at 0.25 BV/min.

In order to further increase the purity of the obtained Tc fraction it might be passed, as described above, through a C8 Resin, and potentially even AlOxAl Resin.

Main Applications:

- Separation of technetium
- Separation of rhenium

TK-TcScint

The TK-TcScint Resin is the first of a range of resins based on “Impregnated Plastic Scintillation microspheres” developed by García, Tarancón and Bagán at the University of Barcelona.

This range of new products will be comprised of plastic scintillation microsphere (PSm), supplied by the group at the University of Barcelona, that are impregnated with selective extractants.

The TK-TcScint Resin is, as the name indicates, mainly dedicated to the quantification of Tc-99. The extractant used in its fabrication is Aliquat336, it further contains small amounts of a long-chained alcohol. Accordingly, its selectivity will generally be very similar to the TEVA Resin.

The figures below (a and b) show SEM pictures of the non-impregnated PSm, and the impregnated microspheres (TK-TcScint), respectively.

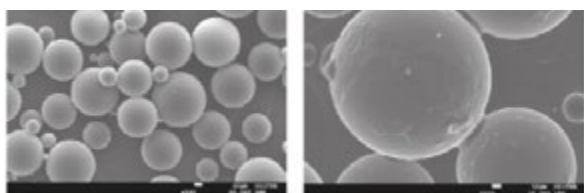

Figure 1 (a and b): left - non-impregnated plastic scintillation microspheres (PSm), right - impregnated PSm (TK-TcScint). Taken from Garcia et al.

The TK-TcScint is generally employed as pre-packed 2 mL cartridges for use with vacuum box systems, or automatized separation equipments based on pump systems

The PSm support employed in the TK-TcScint Resin is itself acting as scintillating medium, this allows for a direct measurement of the Tc-99 retained on the cartridge, no elution and mixing of the eluate with a liquid scintillation cocktail is necessary.

This has a number of advantages:

- Gain of time which is particularly interesting in emergency situations
- No mixed liquid radioactive waste
- No Tc elution with HNO_3 of elevated concentration and no evaporation / aliquoting of the eluate
- No cutting of columns or cartridges to push the resin into LSC vials

Especially the latter two points are interesting in terms of radiation protection when samples of elevated activity are being analyzed.

Ideally the chemical yield is determined via ICP-MS or ICP-OES using Re as internal standard.

The following graph compares this new approach based on impregnated PSm Resins such as the TK-TcScint with classical methods.

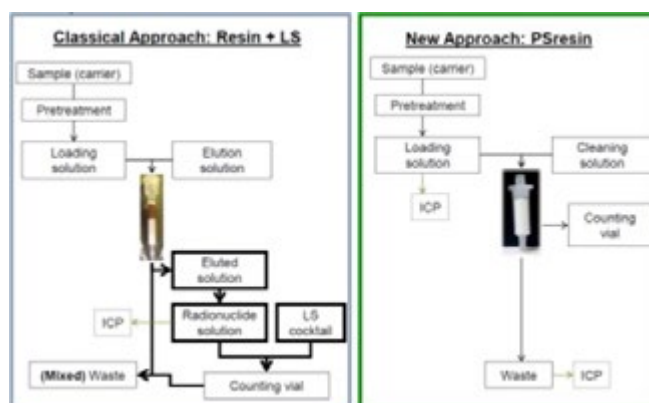

Overview classical radioanalytical method and PS Resin approach. Taken from Garcia et al.

In order to easily handle and avoid contaminating the LSC counter the cartridges should be placed in a standard 20 mL LSC vial for its measurement.

Typical samples analysed include urine and various types of water sample. In case of surface water samples generally a breakthrough volume of > 200 mL can be achieved using 2 mL cartridges, making this technique not only interesting in emergency situations or as screening tool in decommissioning, but also for use in routine biomedical or environmental monitoring. For water samples the chemical yield is generally >98.8%.

The detection efficiency for Tc-99 obtained with the TK-TcScint is very high, in the order of 89.5(0.6)%, while the background of the standard 2 mL cartridges is low with ~1.09 CPM (obtained in Quantulus™ detector in the high-energy and low-coincident bias configuration).

Further the TK-TcScint cartridges show reproducibly low quench with a mean SQP(E) of 787(7).

The figure below shows typically obtained Tc-99 spectra, as can be seen spectra obtained for three replicates match very well.

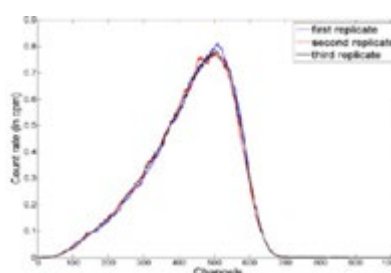

Liquid Scintillation Spectrum of Tc-99 on TK-TcScint. Taken from Garcia et al.

The analysis of water samples such as e.g. river and sea water (typically 50 mL) using TK-TcScint cartridges is rather straightforward

After filtration, if necessary, samples are heated to 90°C for 60 min after addition of a few mL of 30% H₂O₂ to assure that Tc is present as pertechnetate. The solutions are then adjusted to 0.1M HCl using conc. HCl. Once the samples reach room temperature, they are ready for separation.

After loading of the sample the cartridge is typically rinsed successively with 0.1M HCl, 0.1M HNO₃/0.1M HF (only necessary in case Th is expected to be present) and finally water.

These rinses allow eliminating possible interferences while Tc (and the internal standard Re) remain on the cartridge. Load and rinse fractions are combined and analysed for Re content to allow calculating the chemical yield of the separation. The TK-TcScint cartridge can then be directly counted on an LSC counter.

The authors found very good match between expected and measured activities, for the spiked water samples as well as for two spiked MAPEP samples.

Using 50 mL samples and 180 min counting time allowed the authors obtaining a limit of detection of 0.15 Bq.L⁻¹.

As could further be shown by the authors, this method can easily be automatized. In their case they developed their own separation unit called OPENVIEW-AMSS, a modular, vacuum box based equipment. They could show that both, manual and automatized separations allow for obtaining high chemical yields and detection efficiencies, no significant differences were observed when analysing samples in parallel. However, with respect to hands-on time and radiation protection automatization provides significant advantages. Further to the unit developed by the authors the

TK-TcScint cartridges are also compatible with commercially available equipment such as the Hidex Q-Are 100

Besides water samples urine samples were also analysed using TK-TcScint cartridges.

With respect to their higher matrix load this kind of samples requires a thorough sample pre-treatment. The described method is based on 100 mL urine samples that are first wet-ashed using conc. HNO₃, followed by an additional ashing step in a muffle furnace at 550°C.

The obtained ash is then dissolved in 3 mL of conc. HNO₃ and diluted to 100mL using deionized water. To assure Tc is present as pertechnetate the solutions are heated, after addition of a few mL hydrogen peroxide, to 90°C for 60min. As described before, Re was used as internal standard.

By analysing spiked urine samples the authors could show that accurate results can be obtained using the impregnated PSm approach. A minimum detectable activity (MDA) of 0.036 Bq.L⁻¹ for 100mL samples and 24h counting was reported.

Further to the analysis of Tc-99, PSm Bagán et al. showed that Aliquat 336 impregnated resins may also be used for the analysis of [¹⁴C]SCN⁻ used as radiotracer for study of oil reservoir dynamics.

With respect to the selectivity of the Aliquat extracant, the compound giving TEVA Resin its selectivity, a use of the TK-TcScint cartridges for the screening of other radioelements such as e.g. Pu isotopes or Po-210 seems well possible.

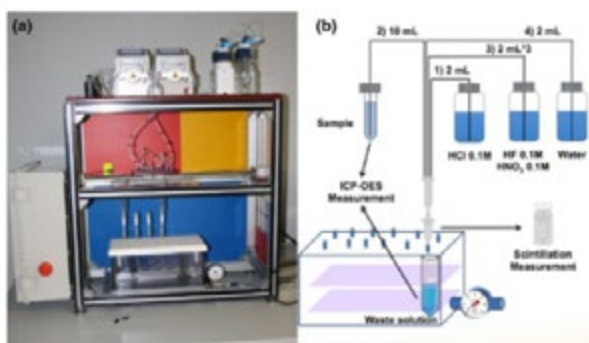

OPENVIEW-AMSS system and scheme of a typical separation of water samples. Taken from Coma et al



Main Applications :

- Separation and LSC measurement of technetium

UPCOMING NEW PRODUCTS

TK222 RESIN

The TK222 Resin is based on a mixture of a branched diglycolamide and a phosphine oxide. It additionally contains a small amount of a long-chained alcohol. Further, the organic phase is impregnated onto an inert support containing aromatic groups for increased stability against radiolysis. TK222 resin is currently mainly being tested for use in Ac-225 purification, and in the purification of lanthanides, especially heavy lanthanides such as Lu-177. Some first technical information is shown below.

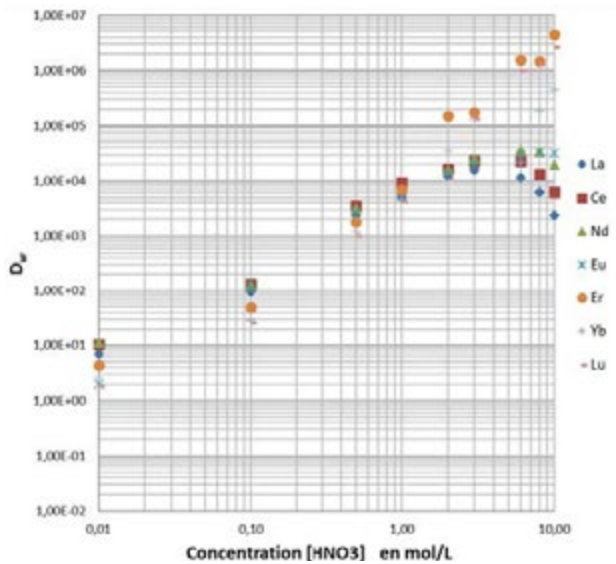

D_w values of selected elements on TK222 in HNO_3

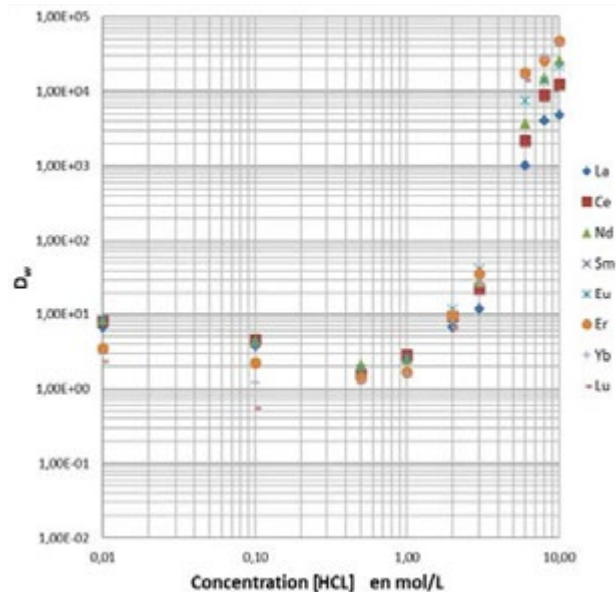

D_w values of selected elements on TK222 in HCl

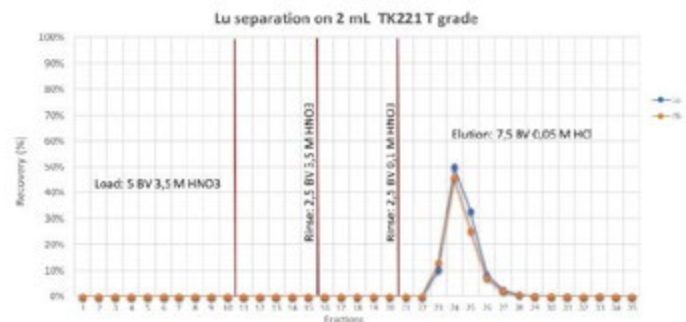
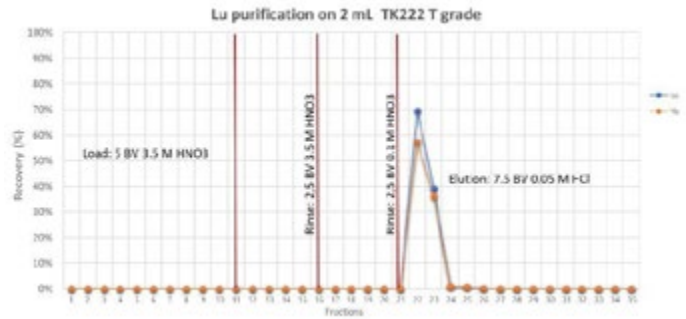

Comparative elution study: Lu purification on TK221 (T grade) and TK222 (T grade), 2 mL cartridges

Weight distribution ratio of Ac on TK221 and TK222 resins

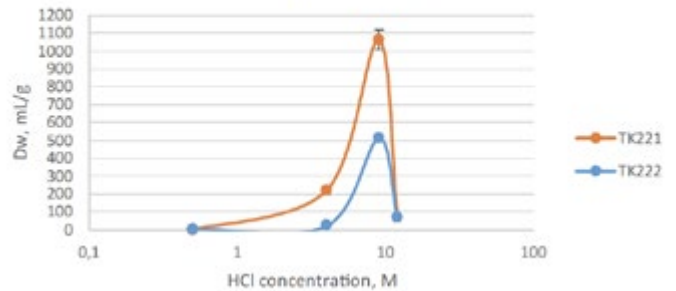

D_w values of Ac of TK221 and TK222 in HCl

Samples of the TK222 Resin are available upon request at contact@triskem.fr



Main Applications :

- Ac Purification
- Lu-177 Purification

CU Sheets

The upcoming new CU Sheets are comprised of a routinely used iTLC paper impregnated with the same extractant that is also used in the CU Resin. The graph below compares the performance of these new CU Sheets with other routinely used TLC papers.

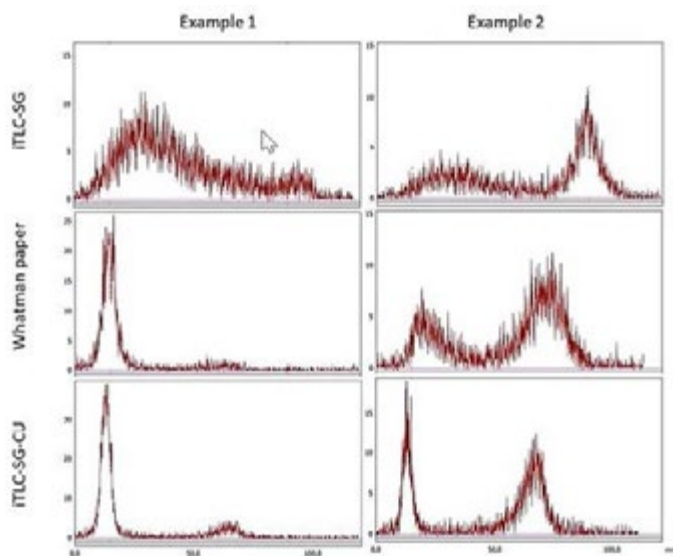

TLC scans of [^{61}Cu]Cu-NOTA-octreotide spotted on: top, iTLC-SG; middle, Whatman paper; bottom, extractant-impregnated iTLC-SG (CU Sheets).

'Example 1' notes elevated levels of unlabelled ^{61}Cu , while 'Example 2' notes comparable levels of labelled to unlabelled ^{61}Cu .

Data courtesy of Svedjehed et al.: "New extractant-impregnated iTLC-SG paper facilitates improved TLC analysis for Cu radiolabelled peptides", poster presented at TERACHEM 2022, 14 – 17 September 2022, Bressanone (Italy). Poster available online on our website.

Samples of the CU Sheets are available upon request at contact@triskem.fr. Please also contact us in case you are interested in other types of 'Sheets'

Impregnated membrane filters

A new range of impregnated membrane filters, based i.e. on the extractants employed in TK201 Resin, TK100 Resin, CL Resins,... will be available soon. The membrane filters will be available in two sizes, 47mm and 25mm. Their main applications will be the separation of analytes from water samples using a filtration unit and passive sampling via DGT [Diffusive Gradients in Thin Films].



Main Applications :

- Tc-99 in water samples (TK201)
- Radioiodine in water (CL Resin)
- Pb in water samples (TK100)
- Pb, Sr, Zn via DGT (TK100)

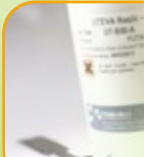

Main Applications :

- QC of Cu radiolabelled compounds

REFERENCES

- J. L. Cortina and A. Warshawsky Ion Exchange and Solvent Extraction; Marinsky, J.A., Marcus, Y., Eds.; Marcel Dekker: , 1997; Vol. 13, p.195.
- M. L. Dietz, E. P. Horwitz, and A. H. Bond.» Metal in Separation and Preconcentration: Progress and Opportunities, Bond, A. H., Dietz, M. L., , R.D., Eds.; ACS Symposium Series 716, ACS, , 1999, pp. 234-250.
- E. P. Horwitz, R. Chiarizia, and M. L. Dietz, Solvent Extr. Ion Extr. 1992, Vol. 10, pp. 313-336.
- E. P. Horwitz, M. L. Dietz, R. Chiarizia, H. Diamond, S. L. Maxwell, III, and M. R. Nelson, Anal. Chim. Acta 1995, Vol. 310, pp. 63-78.
- E. P. Horwitz, R. Chiarizia, and M. L. Dietz, Reactive and Functional Polym. 1997, Vol. 33, pp. 25-36.
- E. P. Horwitz and C. A. A. Bloomquist, J. Inorg. Nucl. Chem. 1972, Vol. 34, pp. 3851-3871.
- E. P. Horwitz and C. A. A. Bloomquist, J. Inorg. Nucl. Chem. 1973, Vol. 35, pp. 271-284.
- E. P. Horwitz, M. L. Dietz, R. Chiarizia, and R. C. Gatrone and A. M. Essling, R. W. Bane, and D. Graczyk, Anal. Chim. Acta 1992, Vol. 266, pp. 25-37.
- E. P. Horwitz, R. Chiarizia, M. L. Dietz, H. Diamond, and D. M. Nelson, Anal. Chim. Acta 1993, Vol. 281, 361-372.
- E. P. Horwitz and C. A. A. Bloomquist, J. Inorg. Nucl. Chem. 1975, Vol. 37, pp. 425-434.
- E. P. Horwitz, M. L. Dietz, S. Rhoads, C. Felinto, N. H. Gale and J. Houghton, Anal. Chim. Acta 1994, Vol. 292, pp. 263-273.
- W. C. Burnett, D. R. Corbett, M. Schultz, E. P. Horwitz, R. Chiarizia, M. Dietz, A. Thakkar, and M. Fern, J. Radioanal. Nucl. Chem. 1997, Vol. 226, p. 121.
- Horwitz E.P., McAlister D.R., Bond A.H., Barans R.E., Solvent Extrac. Ion Exch., 23, 219 (2005).
- Horwitz E.P., Bond A.H., Barans R.E., McAlister D.R., 27th Actinide separations Conferences, (2003).
- Moon D.S., Burnett W.C., Nour S., Horwitz P., Bond A., Applied Rad. Isot., 59, 255 (2003).
- Maxwell, S.L., presented at Eichrom's North American Users' Meeting, , May 3, 2005, see www.eichrom.com.
- Cahill D. F., Peedin L. M., presented at 41st Annual Conference on Bioassay, Analytical and Environmental Chemistry, Eichrom workshop, Boston, MA – USA
- Esser B.K. et al., Anal. Chem., Vol.66, 1736 (1994)
- McAlister D., Horwitz E.P., Solvent Extrac. Ion Exch, 25 (6), 757–769 (2007)
- A. Zulauf, S. Happel, M. B. Mokili et al, J. Radanal Nucl Chem, 286(2), 539-546
- P E Warwick, A Zulauf, S Happel, I W Croudace, presented at the 11th ERA Symposium, 16/09/2010, Chester (UK), see www.triskem.com
- C. Dirks, B. Scholten, S. Happel et al., J Radioanal. Nucl. Chem, 286 (2010) 671-674
- C. Dirks, S. Happel, presented at the Triskem International users group meeting, 14/09/2010, Chester (UK), see www.triskem.com
- Chiarizia, R., Sep. Sci. Technol., 32, 1997, 1 – 35
- Kim G., Burnett W.C., Horwitz E.P., Anal. Chem., 72, 2000, 4882-4887
- Shaw D.R. et al., JOM, July 2004, 38 – 42
- Hines, J.J.; et al, Sep Sci Technol, 30(7-9), 1995, 1373 – 1384
- Surbeck H., presented at ICRM Conference on Low Level Radioactivity Measurement Techniques 18-22nd October 1999, Mol, Belgium, see www.nucfilm.com
- Mendes M, Aupiais J, Jutier C, Pointurier F. Anal Chim Acta. 2013 May 30;780:110-6
- Horwitz E.P., Dietz M.L., Rhoads S., Felinto C., Gale N.H., Houghton J.; Analytica Chimica Acta, Vol.292, p263-273 (1994)
- Nottoli E, Bienvenu P, Labet A, Bourlès D, Arnold M, Bertaux M. Appl Radiat Isot. 2014 Apr;86:90-6. doi: 10.1016/j.apradiso.2014.01.010.
- Horwitz P, McAlister D. Old Separations on New Resins and New Separations on Old Resins. RRMCM, Destin, FL 2008
- Sebesta F, Stefula V (1990) Composite ion exchanger with ammonium molybdophosphate and its properties. J Radioanal Nucl Chem 140(1):15 - 21
- Brewer et al. (1999). Czechoslov J Phys 49(S1):959-964
- Kamenik et al. (2012) J Radioanal Nucl Chem. DOI 10.1007/s10967-012-2007-4
- Kamenik J et al. (2009) Long term monitoring of Cs-137 in foodstuffs in the Czech Republic. Appl Radiat Isot 67(5):974-977
- Bartuskova et al. (2007) Ingestion doses for a group with higher intake of Cs-137.IRPA regional congress for Central and Eastern Europe, Brasov, Romania
- E. P. Horwitz, M. L. Dietz, R. Chiarizia, H. Diamond, S. L. Maxwell, III, and M. R. Nelson, Anal. Chim. Acta 1995, Vol. 310, pp. 63-78.
- Mark L. Dietz, Julie A. Dzielawa, Ivan Laszak, Blake A. Young and Mark P. Jensen: „Influence of solvent structural variations on the mechanism of facilitated ion transfer into room-temperature ionic liquids”, Green Chemistry, 2003, 5, 682–685
- Dirks et al.: “On the development and characterisation of an hydroxamate based extraction chromatographic resin”. Presented at the 61st RRMCM, October 25th - 30th, 2015, Iowa City, IA, USA
- A. Bombard et al. “Technetium-99/99m New Resins Developments For Separation And Isolation From Various Matrices”, presented at the ARCEBS 2018, 11-17/11/18 - Ffort Raichak (India)
- S. Happel: “An overview over some new extraction chromatographic resins and their application in radiopharmacy” presented on the 4th of June 2019 at the 102nd Canadian Chemistry Conference and Exhibition (CCCE 2019) in Quebec City, QC
- S.K. Spear et al., Ind. Eng. Chem. Res., 2000, 39, 3173 – 3180, <https://doi.org/10.1021/ie990583p>
- I.Cieszykowska et al.: “Separation of 99mTc from low specific activity 99Mo”, poster ID 195 presented at the ISTR 2019, October 28 – November 1, Vienna, Austria
- IAEA Nuclear Energy Series, No. NPT-5.4.: “Non-HEU Production Technologies for Molybdenum-99 and Technetium-99m”, INTERNATIONAL ATOMIC ENERGY AGENCY, Vienna, 2013
- F. Bénard et al, Journal of Nuclear Medicine, 2014, <https://doi.org/10.2967/jnumed.114.143834>
- C. Dirks et al., Presented at the 61st RRMCM, October 25th - 30th, 2015, Iowa City, IA, USA
- S. Happel: “An overview over some new extraction chromatographic resins and their application in radiopharmacy”, Version 12/06/2021, https://www.triskem-international.com/scripts/files/60c4a63e7a4475.44279512/tki_rp_210612.pdf, accessed on 15/07/2021
- J. P. Holland et al., Nucl Med Biol., 36(7), 2009, 729–739; doi:10.1016/j.nucmedbio.2009.05.007
- Nair M, et al., Eur J Nucl Med Mol Imaging. 2017;44(Suppl 2):S119–956.
- Stefano Riga et al., Physica Medica, Volume 55,2018, 116-126. <https://doi.org/10.1016/j.ejmp.2018.10.018>
- Rodnick, M.E. et al., EJNMMI radiopharm. chem. 5, 25 (2020). <https://doi.org/10.1186/s41181-020-00106-9>
- Thisgaard, H. et al., EJNMMI radiopharm. chem. 6, 1 (2021). <https://doi.org/10.1186/s41181-020-00114-9>
- V. Radchenko et al., Journal of Chromatography A, Volume 1477, 2016, 39-46, <https://doi.org/10.1016/j.chroma.2016.11.047>.
- Mario Malinconico et al., Journal of Nuclear Medicine May 2018, 59 (supplement 1) 664. https://jnm.snmjournals.org/content/59/supplement_1/664
- Coma et al., Journal of Radioanalytical and Nuclear Chemistry (2019) 321:1057–1065. <https://doi.org/10.1007/s10967-019-06659-7>
- Barrera et al., Analytica Chimica Acta 936 (2016) 259-266. <https://doi.org/10.1016/j.aca.2016.07.008>
- Tarancon et al. “A new plastic scintillation resin for single-step separation, concentration and measurement of 99Tc”, presented at the NRC9 (29/08/16 – 2/09/16, Helsinki, Finland)
- Hidex eBook “Liquid Scintillation Measuring Procedures: New Developments” <https://hidex.com/ebooks/liquid-scintillation-measuring-procedures/measuring-procedures/radionuclides-from-nuclear-fission-activities/2-3-14-tc-by-rad-disk-and-ps-resins/>
- J. Garcia & A. Tarancon, “Radionuclide determinations with PS Resin MASS WaterRadd”, presented at the European Users Group Meeting in Cambridge (UK) - 21/09/2018, https://www.triskem-international.com/scripts/files/5bae2550c30ed4.50583030/11_j-garcia_a-tarancon_radionuclide-determinations-with-ps-resin_mass_waterradd.pdf
- H. Bagán et al., Analytica Chimica Acta, 736, 2012, 30-35, <https://doi.org/10.1016/j.aca.2012.05.045>
- Illarion Dovhy, Marine Bas, Nora Vajda et al. : “Characterization of new crown-ether containing TK102 Resin for the separation of Sr, Pb and Ba/Ra”, Poster presented at the 14th International Symposium on Nuclear and Environmental Radiochemical Analysis from 12 – 15/09/2022 in York (UK). <https://www.triskem-international.com/scripts/files/63317f16990d61.93025432/poster-tk102-v1.pdf>

Products	Applications *
CL Resin	I removal from effluents, Ag, Pa
CU Resin	Cu from liquid Ni targets and from Zn targets
DGA Sheets	Quality control of Ra-223, Pb-212, Ac-225/Bi-213, Ge-68/Ga-68
ZR Resin	Zr, Ga, Ge, Ti
TK101 Resin	Ra, Pb
TK102 Resin	Ra/Ba separation, Pb, Sr
TK200 Resin	Ga-67/8, Zn, Actinides
TK201 Resin	Cu from solid Ni targets, Tc, Re
TK202 Resin	Tc from Mo targets, Re
TK221 Resin	Actinides, Lanthanide separation and purification (e.g. Lu-177), Ac-225 purification
TK225 Resin	Lanthanides removal from acidic effluents
TK211/2/3 Resins	Lanthanide separation (e.g. nca Lu-177, nca Tb-161)
TBP Resin	Sn, Zr, Sc, Ga, Actinides
TK400 Resin	Pa, Ga, Fe, Nb, Mo, Po
Guard Resin	Removal of organic impurities, Ge-68
TK-TcScint	Tc measurement

*the main applications are shown in orange

Upcoming new products :
TK222, CU Sheets,...



TrisKem International

3, Rue des Champs Géons – 35170 Bruz – FRANCE

Tel +33 (0)2 99 05 00 09 – Fax +33 (0)2 23 45 93 19 – www.triskem.com – email : contact@triskem.fr

SAS au capital de 100.000 euros – SIRET 493 848 972 00029 – APE2059Z – TVA intra communautaire FR65 493 848 972

V_0223_R